

Air Force Institute of Technology

**AFIT Scholar**

---

Theses and Dissertations

Student Graduate Works

---

3-2001

## Quantitative Validation of a Model of Chlorinated Ethene Natural Attenuation

Harold C. Young

Follow this and additional works at: <https://scholar.afit.edu/etd>



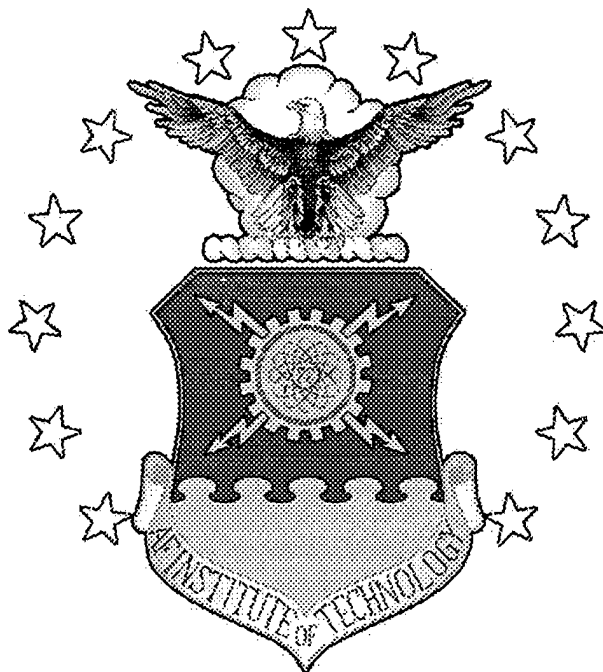
Part of the [Environmental Engineering Commons](#), and the [Water Resource Management Commons](#)

---

### Recommended Citation

Young, Harold C., "Quantitative Validation of a Model of Chlorinated Ethene Natural Attenuation" (2001). *Theses and Dissertations*. 4729.  
<https://scholar.afit.edu/etd/4729>

This Thesis is brought to you for free and open access by the Student Graduate Works at AFIT Scholar. It has been accepted for inclusion in Theses and Dissertations by an authorized administrator of AFIT Scholar. For more information, please contact [richard.mansfield@afit.edu](mailto:richard.mansfield@afit.edu).



**QUANTITATIVE VALIDATION OF A MODEL  
OF CHLORINATED ETHENE NATURAL  
ATTENUATION**

THESIS

Harold C. Young, Captain, USMC

AFIT/GEE/ENV/01M-25

DEPARTMENT OF THE AIR FORCE  
AIR UNIVERSITY

**AIR FORCE INSTITUTE OF TECHNOLOGY**

---

---

Wright-Patterson Air Force Base, Ohio

APPROVED FOR PUBLIC RELEASE; DISTRIBUTION UNLIMITED.

20010612 146

The views expressed in this thesis are those of the author and do not reflect the official policy or position of the United States Air Force, Department of Defense, or the U. S. Government.

AFIT/GEE/ENV/01M-25

QUANTITATIVE VALIDATION OF A MODEL OF CHLORINATED ETHENE  
NATURAL ATTENUATION

THESIS

Presented to the Faculty

Department of Systems and Engineering Management

Graduate School of Engineering and Management

Air Force Institute of Technology

Air University

Air Education and Training Command

In Partial Fulfillment of the Requirements for the  
Degree of Master of Science in Engineering and Environmental Management

Harold C. Young, B.S.

Captain, USMC

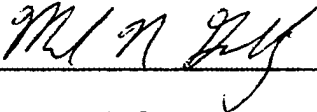
March 2001

APPROVED FOR PUBLIC RELEASE; DISTRIBUTION UNLIMITED.

QUANTITATIVE VALIDATION OF A MODEL OF CHLORINATED ETHENE  
NATURAL ATTENUATION

Harold C. Young, B.S.  
Captain, USMC

Approved:



---

Dr. Mark N. Goltz  
Chair, Advisory Committee

28 Feb 01

Date



---

Dr. Charles A. Bleckmann  
Member, Advisory Committee

2/28/01

Date

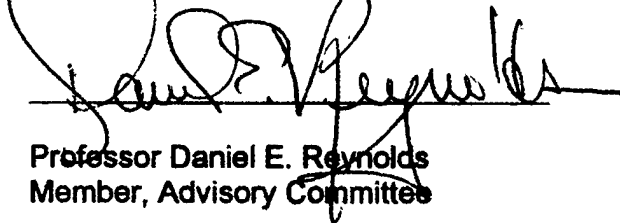


---

Dr. Junqi Huang  
Member, Advisory Committee

2/28/2001

Date



---

Professor Daniel E. Reynolds  
Member, Advisory Committee

2/28/2001

Date

## Acknowledgements

This thesis would not have been possible without the unwavering dedication, support, and enthusiasm of several key individuals. I would like to thank Dr. Charles Bleckmann, who was able to decipher the language of microbiology into words that I could understand. Next, to Dr. Junqi Huang, whose ability to translate complex ideas into workable FORTRAN code is humbling. Without his efforts, this research would have been an utter failure. I am also grateful to Dr. Daniel Reynolds, whose endless exuberance and zeal in the teaching of probability and statistics motivated me to investigate this area of study. And, of course, to Dr. Mark Goltz, for being an exceptional instructor, counselor, leader, and role model. Finally, I wish to thank my wife, [REDACTED]. Only one so devoted and unselfish could have supported me through this challenge.

Harold C. Young

## Table of Contents

	Page
Acknowledgements .....	iii
List of Figures.....	vi
List of Tables.....	vii
Abstract.....	viii
1.0 Introduction.....	1
1.1 Motivation.....	1
2.0 Literature Review .....	7
2.1 Overview .....	7
2.2 Models.....	7
2.2.1 Definition, Importance, and Uses.....	7
2.2.2 Processes Modeled .....	8
2.2.2.1 Physicochemical Processes.....	9
2.2.2.2 Biological Processes .....	14
2.2.2.2.1 Cometabolic Reductive Dehalogenation.....	15
2.2.2.2.2 Reductive Dehalogenation Through Halorespiration .....	16
2.2.2.2.3 Cometabolic Oxidation.....	17
2.2.2.2.4 Aerobic Oxidation .....	17
2.2.2.2.5 Anaerobic Oxidation .....	17
2.2.2.2.6 Mathematical Description of Contaminant Biodegradation ....	18
2.2.3 Models Relevant to the Simulation of Chlorinated Ethene Natural Attenuation .....	22
2.2.3.1 Biochlor .....	22
2.2.3.2 Bio-Redox .....	23
2.2.3.3 RT3D.....	23
2.2.3.4 BR3D .....	24
2.3 Model Validation.....	25
2.3.1 Model Verification .....	26
2.3.2 Model Calibration.....	27
2.3.3 Comparative Analysis .....	30
2.3.3.1 Qualitative Comparative Analysis.....	30
2.3.3.2 Quantitative Comparative Analysis .....	31
2.4 Case Studies Using Models to Simulate the Natural Attenuation of Chlorinated Solvents .....	40
3.0 Methodology.....	43
3.1 Overview .....	43
3.2 Code Selection.....	43
3.2.1 Characteristics of the Site.....	43
3.2.2 Criteria for Code Selection.....	46
3.2.3 Code Selected to Represent Site LF-03 .....	47
3.3 Code Application to Site LF-03.....	48
3.3.1 Groundwater Flow Model.....	50
3.3.2 Contaminant Fate and Transport Model .....	52
3.3.2.1 Processes Modeled.....	52

	Page
3.3.2.2 Initial and Boundary Conditions.....	55
3.4 Site Model Validation.....	55
3.4.1 Calibration.....	57
3.4.2 Quantitative Comparative Analysis .....	59
4.0 Analysis .....	60
4.1 Calibration Results .....	60
4.2 Predictive Simulation and Comparative Analysis .....	66
5.0 Conclusion.....	71
5.1 Summary .....	71
5.2 Calibration .....	71
5.3 Predictive Simulation and Quantitative Comparative Analysis .....	72
5.4 Areas for Further Research .....	73
6.0 Bibliography.....	76
Vita.....	85



## List of Figures

	Page
Figure 2.1 Linear Sorption Isotherm (after Fetter (1993)).....	11
Figure 2.2 Freundlich Isotherm (after Fetter (1993)) .....	12
Figure 2.3 Langmuir Isotherm (after Fetter (1993)) .....	13
Figure 2.4 First Order Biodegradation .....	18
Figure 2.5 Example of a Model a) with Bias, and b) without Bias.....	32
Figure 2.6 Unbiased Model that Fails to Match Observed Data .....	34
Figure 2.7 Plot of Simulated and Observed Values.....	36
Figure 2.8 Insensitivity of Sample Correlation Coefficient to Bias .....	38
Figure 3.1 Model Domain (after Parsons Engineering Science (1999)) .....	49
Figure 3.2 Shallow Groundwater Surface (after Parsons Engineering Science (1999)).....	51
Figure 3.3 Model Source Area Configuration (after Parsons Engineering Science (1999)).....	56
Figure 4.1 Calibration of TCE First Order Decay Constant .....	60
Figure 4.2 Calibrated TCE Concentration Contour Plot, Layer 1 (g/L) .....	62
Figure 4.3 1993 Observed TCE Concentration Contour Plot, Layer 1 (g/L) .....	62
Figure 4.4 Calibrated DCE Concentration Contour Plot, Layer 1 (g/L) .....	63
Figure 4.5 1993 Observed DCE Concentration Contour Plot, Layer 1 (g/L).....	63
Figure 4.6 Calibrated VC Concentration Contour Plot, Layer 1 (g/L) .....	64
Figure 4.7 1993 Observed VC Concentration Contour Plot, Layer 1 (g/L) .....	64
Figure 4.8 Simulated (a) and Observed(b) TCE Concentrations for 1999.....	68
Figure 4.9 Simulated (a) and Observed (b) DCE Concentrations for 1999 .....	68
Figure 4.10 Simulated (a) and Observed (b) VC Concentrations for 1999 .....	68

## List of Tables

	Page
Table 3.1 Essential Capabilities of Candidate Codes.....	46
Table 3.2 Non-Essential Capabilities of Candidate Codes.....	47
Table 3.3 Groundwater Flow Parameter Values .....	52
Table 3.4 TCE Mass Loading per Cell (in kg/yr) (after Parsons Engineering Science, 1999).....	55
Table 3.5 Observed Chlorinated Ethene Concentrations for 1993 (after Parsons Engineering Science (1999)) .....	57
Table 3.6 Model Parameters Varied During Calibration.....	58
Table 3.7 Model Parameters Held Constant During Calibration.....	58
Table 4.1 Calibrated Model Parameters.....	61
Table 4.2 Goodness-of-Fit Statistics for Model Calibration .....	65
Table 4.3 Observed Chlorinated Ethene Concentrations for 1999 (after Parsons Engineering Science (1999)) .....	67
Table 4.4 Goodness-of-Fit Statistics for 1999 Data.....	69

# QUANTITATIVE VALIDATION OF A MODEL OF CHLORINATED ETHENE NATURAL ATTENUATION

## 1.0 Introduction

### 1.1 Motivation

The contamination of groundwater by chlorinated solvents is a well-recognized problem (Mackay and Cherry, 1989; Adamson and Parkin, 2000). Two chemicals in particular pose a significant threat to human health and the environment: tetrachloroethylene (PCE), and trichloroethylene (TCE). This research will focus on the treatment of aquifers containing PCE and TCE.

Both PCE and TCE are suspected carcinogens (Sturchio et al., 1998), making groundwater contaminated with these compounds a health hazard. People exposed to TCE have reported an excess number of adverse health effects, to include liver and kidney disease, diabetes, and stroke (ATSDR, 1996).

Accordingly, the United States Environmental Protection Agency (USEPA) has set the Maximum Contaminant Level (MCL) for both PCE and TCE in drinking water at five parts per billion (CFR, 2000b) and the Maximum Contaminant Level Goal (MCLG) at zero parts per billion (CFR, 2000a).

The health risk from PCE and TCE is based on exposure as well as toxicity. PCE and TCE are common industrial solvents, used mostly to degrease metal and to produce inks and paints. After years of intentional and unintentional releases, these solvents have infiltrated into the ground and contaminated

underlying aquifers. The extent of contamination across the country is such that the EPA has declared TCE and its degradation products, cis-1,2-dichloroethylene (DCE) and vinyl chloride (VC), to be priority pollutants (Bloom et al., 2000). TCE is the most frequently detected groundwater contaminant at hazardous waste sites in the United States (Bloom et al., 2000). Of the nine Marine Corps facilities on the National Priorities List, eight of them have PCE or TCE contamination of soil or groundwater (USEPA, 2000).

Remediating a contaminated aquifer is not a simple task. Both PCE and TCE are classified as dense non-aqueous phase liquids (DNAPLs). DNAPLs are denser than water, and tend to sink after reaching the water table. While doing so, some of the DNAPL partitions into the aqueous phase and is carried off by groundwater flow. Due to the relatively low solubility of PCE and TCE in water, a DNAPL source can persist for decades (Mackay and Cherry, 1989). While some experiments have had preliminary success (Ho et al., 1999), there is no conventional technology that effectively removes DNAPL sources (NRC, 1999). This research will focus on containment and removal of contaminants from the aqueous phase. At present, there are three strategies being implemented to deal with solvent-laden groundwater: conventional pump and treat, passive barriers, and natural attenuation.

Conventional pump and treat is by far the most common approach to the containment and removal of TCE and PCE. In this strategy, water is pumped to

the surface where contaminants are removed using an engineered treatment process. The treated water is then either returned to the subsurface to prevent aquifer dewatering and to sustain beneficial hydraulic gradients or discharged to surface water. The aboveground contaminant treatment technologies are well understood, as is the hydraulic containment achievable through the use of pumping wells. While pump and treat poses an increased risk to receptors as contaminants are pumped to the surface, the largest drawback of this strategy is its high cost. Due to the fact that pump and treat systems must operate for many years to contain a contaminant plume, lifecycle costs for these systems are quite high. These high costs, as well as the increased risk to potential receptors, have prompted the development of alternative strategies such as passive barriers and natural attenuation to manage contaminated groundwater.

Passive barriers have received increased attention as an effective, low-cost containment strategy. By constructing a trench filled with zero-valent iron filings, a barrier is formed that contaminated groundwater flows through. As PCE and TCE are transported through the barrier, they are reductively dechlorinated in the trench. While this technology is fairly well understood and cost effective, it has its limitations. The system is only appropriate for relatively shallow aquifers, as the technology is limited to the depth a trench can be placed. Also, the passive barrier may be bypassed due to fluctuations in groundwater flow, and the effective life of the iron filings is a major uncertainty (NRC, 1999).

Another strategy that has gained acceptance over the years as a low-cost option is natural attenuation. The Environmental Protection Agency defines natural attenuation in the following manner:

The term “monitored natural attenuation,” as used in this Directive, refers to the reliance on natural attenuation processes (within the context of a carefully controlled and monitored clean-up approach) to achieve site-specific remedial objectives within a timeframe that is reasonable compared to that offered by other more active methods. The “natural attenuation processes” that are at work in such a remediation approach include a variety of physical, chemical, or biological processes that, under favorable conditions, act without human intervention to reduce the mass, toxicity, mobility, volume, or concentration of contaminants in soil and groundwater. These *in-situ* processes include biodegradation; dispersion; dilution; sorption; volatilization; radioactive decay; and chemical or biological stabilization, transformation, or destruction of contaminants (USEPA, 1999).

While chlorinated solvents are resistant to biodegradation, they have been demonstrated to degrade to innocuous compounds, such as ethene, under appropriate conditions (Maymo-Gatell et. al., 1999). Natural attenuation of chlorinated compounds in an aquifer by indigenous microorganisms is typically very cost effective, with the main expenses being site characterization and monitoring. However, as MNA is dependent upon natural processes taking place in the subsurface (as compared to the engineered processes discussed above), the contaminant-removal mechanisms are the least understood. Recently, natural attenuation has come under criticism for being used in situations where its effectiveness has not been adequately demonstrated. According to a report from the National Research Council (NRC), “natural attenuation should only be accepted as a formal remedy for contamination only when the processes are documented to be working and are sustainable” (NRC, 2000). The EPA states

natural attenuation “should be used with caution commensurate with the uncertainties associated with the particular applications,” and that “the hydrologic and geochemical conditions favoring significant biodegradation of chlorinated solvents sufficient to achieve remediation objectives within a reasonable timeframe are anticipated to occur only in limited circumstances” (USEPA, 1999). One way to demonstrate that natural attenuation may be occurring in the subsurface is to apply a model. Several computer models have been presented that simulate the natural attenuation of PCE and TCE (Feng, 2000; Clement et al., 1999), but few have been validated using data from a contaminated site. Model validation could result in increased credibility for natural attenuation as a remediation strategy for chlorinated solvent contamination, with a subsequent rise in implementation and reduction in overall costs.

The purpose of this research is to validate a computer model by comparing its output to data collected from the field. This research will be limited to PCE and TCE degradation in saturated groundwater systems. A review of current literature will focus on 1) important physico-chemical and biological processes thought to take place in the subsurface, 2) numerical models that can simulate those processes, 3) model validation strategies, 4) previous model validation efforts, and 5) a list of sites that could support future validation studies. After the literature review, a model will be selected and applied to a chosen site. A simulation will be run, and the model’s prediction will be statistically evaluated against field data. It is hoped that this method of model validation will prove

useful in the validation of other contaminant fate and transport models. It is also hoped that this effort will generate further understanding of the mechanisms of natural attenuation of chlorinated solvents in aquifer systems.



## **2.0 Literature Review**

### **2.1 Overview**

The purpose of this literature review is to provide background information on validation methods as they may be applied to modeling natural attenuation of chlorinated solvents in an aquifer. To this end, this review covers three major areas. First, models will be discussed, including the definition and importance of models in the study of contaminated aquifers, the natural attenuation processes thought to take place in the saturated zone, and the numerical models that simulate natural attenuation processes. Second, the concept of model validation will be introduced, and will include a discussion of model verification, calibration, and comparative analysis. Third, several cases involving model application to chlorinated ethene-contaminated sites will be reviewed to illustrate common model validation practices.

### **2.2 Models**

#### **2.2.1 Definition, Importance, and Uses**

A model may be defined as “a representation of a real system or process” (Konikow and Bredehoeft, 1992). Within this definition, there is a wide array of models that differ greatly in purpose, application, structure, and complexity. This research will focus on numerical models that represent the fate and transport of chlorinated ethenes in an aquifer.

Numerical models are approximations of the exact mathematical solution of the governing equation(s) that describe real systems and processes. These models rely on fewer simplifying assumptions than analytical models that solve the governing equation(s) exactly, and are capable of addressing difficult problems such as heterogeneous conditions and complex initial and boundary conditions (Weaver, et al., 1989). The Environmental Protection Agency (EPA) uses numerical models in a predictive mode to make regulatory assessments and environmental decisions (Weaver, et al., 1989). Numerical models have also been used in courtroom litigation to establish liability (Bair, 1994). Perhaps more important than the predictive capability of a model is its explanatory power. According to Murphy and Ginn (2000), who specifically comment upon modeling the microbial processes that occur during natural attenuation, "progress in modeling microbial processes in porous media is essential to improving our understanding of how physical, chemical, and biological processes are coupled in groundwater and their effect on groundwater-chemistry evolution, bioremediation, and the reactive transport of contaminants and bacteria." The remainder of this section will be devoted to describing the processes thought to occur in chlorinated ethene-contaminated aquifers and the numerical models that simulate those processes.

### **2.2.2 Processes Modeled**

Only the natural attenuation processes thought to be important to the fate and transport of chlorinated ethenes and their daughter products will be studied.

These processes can be divided into two major categories: physiochemical processes and biological processes.

### **2.2.2.1 Physicochemical Processes**

The physicochemical processes of advection, dispersion, and sorption play a crucial role in the fate and transport of contaminants. Advection is the transport of mass due to the bulk flow of groundwater, and is “by far the most dominant mass transport processes” (Dominico and Schwartz, 1998). Dominico and Schwartz (1998) provide equations describing the advective transport of contaminants.

In almost all cases, mass is transported beyond the region delineated solely by advective transport. This is due to dispersion, which is the spreading of mass due to fluid mixing. Dispersion is caused by molecular diffusion (Brownian motion) as well as mechanical mixing within a heterogeneous aquifer.

Dispersion is often modeled as diffusion, as the outcome of each mechanism is similar (Dominico and Schwartz, 1998). Clark (1996) provides a detailed explanation of the equations used to describe dispersion.

Contaminants, especially non-polar organic compounds such as PCE and TCE, typically do not move as quickly as predicted by advection and dispersion. This delayed contaminant movement, or retardation, is caused by several mechanisms that are collectively termed sorption. Sorption is defined as the

partitioning of contaminant from the aqueous phase (i.e. dissolved in groundwater) to the aquifer solids. In this research, the dominant sorption process involves organic contaminants being sorbed to the organic material found on aquifer solids. The amount of sorption that takes place is dependent upon temperature, concentration of the contaminant, and the characteristics of both the contaminant and the aquifer solids.

A set of experiments can be run to determine the relation at equilibrium between aqueous contaminant concentration (mass of contaminant per volume water) and sorbed concentration (mass of contaminant per mass of sorbent). As these experiments are performed at the same temperature, the relationship is referred to as a sorption isotherm.

If sorption occurs quickly with respect to groundwater flow, then it is assumed that the rate at which mass is being sorbed to the solids is equal to the rate at which mass is being desorbed. This is called the local equilibrium assumption (LEA). In this case, the partitioning process is said to be in equilibrium and is best described as an equilibrium sorption isotherm. Equilibrium sorption isotherms may either be linear or non-linear. According to Fetter (1993), a linear isotherm can be described by the equation

$$C^* = K_d C \quad (2.1)$$

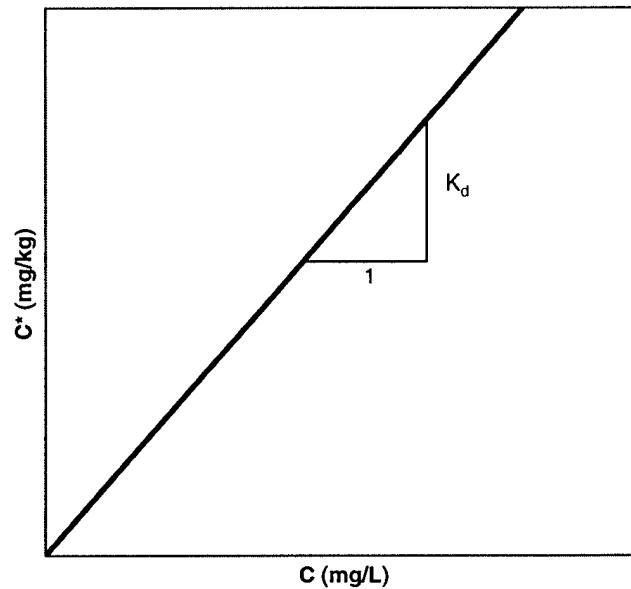
where

$C^*$  = mass of contaminant sorbed per dry unit weight of solid (M/M)

$C$  = concentration of contaminant in solution ( $M/L^3$ )

$K_d$  = distribution coefficient ( $L^3/M$ )

Figure 2.1 is an example of a linear isotherm.



**Figure 2.1 Linear Sorption Isotherm (after Fetter (1993))**

As can be observed from Figure 2.1, the major drawback of describing sorption with a linear isotherm is that there is no apparent limit to the amount of contaminant that may be sorbed. As no real material can sorb an endless amount of mass, linear models are typically used only at relatively low concentration levels or within a small range of contaminant concentrations.

When describing sorption over a wide range of contaminant concentrations, non-linear isotherms typically perform better than linear isotherms. Non-linear sorption isotherms describe a curvilinear relationship between sorbed contaminant concentration and dissolved concentration. The Freundlich

isotherm is a commonly used non-linear sorption isotherm, and is described by the following equation:

$$C^* = KC^N \quad (2.2)$$

where

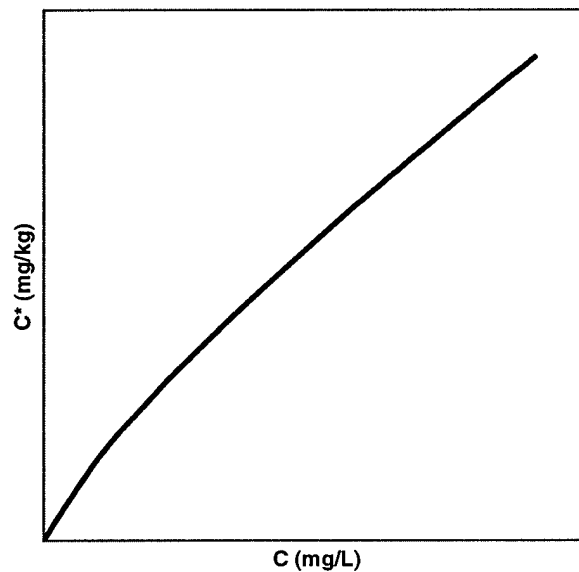
$C^*$  = mass of contaminant sorbed per dry unit weight of solid (M/M)

$C$  = concentration of contaminant in solution (M/L<sup>3</sup>)

$K$  = constant

$N$  = constant (-)

Figure 2.2 illustrates a Freundlich sorption isotherm with  $K = 28$  and  $N = 0.62$  (Clark, 1996).



**Figure 2.2 Freundlich Isotherm (after Fetter (1993))**

Note that the Freundlich isotherm suffers from the same problem as the linear isotherm. That is, the amount of contaminant that can be sorbed by aquifer solids is essentially unlimited. This problem can be addressed through the use of the Langmuir sorption isotherm.

The Langmuir isotherm is a non-linear isotherm that is based on the assumption that aquifer solids have a limited number of sites available for contaminant sorption. The Langmuir isotherm is given by

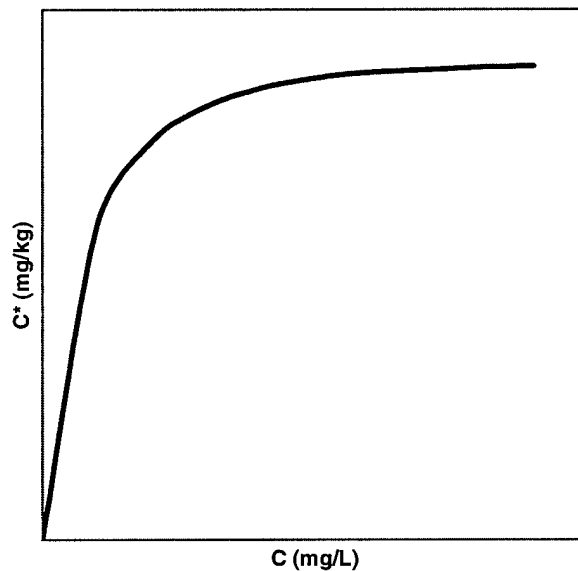
$$\frac{C}{C^*} = \frac{1}{\alpha\beta} + \frac{C}{\beta} \quad (2.3)$$

where

$\alpha$  = an absorption constant related to the binding energy ( $L^3/M$ )

$\beta$  = the maximum amount of solute that can be absorbed by the solid (M/M)

Figure 2.3 is a graph of a Langmuir isotherm with a value of  $\alpha$  of 0.9 and  $\beta$  of 0.9.



**Figure 2.3 Langmuir Isotherm (after Fetter (1993))**

Not all groundwater systems can be described with equilibrium isotherms. In some aquifers, sorption takes place at approximately the same rate as the velocity of groundwater. In these systems, local equilibrium cannot be assumed. Such systems are more appropriately described by non-equilibrium, or rate-

limited, sorption models. These models are significantly more complicated than equilibrium isotherms, and are beyond the scope of this research. Fetter (1993) and Feng (2000) contain detailed discussions on commonly used rate-limited models.

#### **2.2.2.2 Biological Processes**

While the primary physicochemical processes either spread the contaminant (advection and dispersion) or temporarily sequester it (sorption), they do not reduce the overall mass of contaminant within the aquifer. Conversely, it has been demonstrated that microorganisms are capable of catalyzing chemical reactions that result in the degradation of chlorinated ethenes (Wilson and Wilson, 1985). This research will cover the microbially-mediated reductive and oxidative processes known to degrade chlorinated ethenes in contaminated aquifers.

Oxidation-reduction (redox) reactions involve the transfer of an electron from an electron-rich chemical, or electron donor, to an electron-poor chemical, or electron acceptor (NRC, 2000). Microorganisms catalyze redox reactions with enzymes and cofactors in order to generate the adenosine triphosphate (ATP) needed to sustain metabolism and growth. The amount of ATP generated depends on the electron donor and electron acceptor used (NRC, 2000). The most common oxidation-reduction reactions that degrade chlorinated ethenes are discussed below.



#### **2.2.2.2.1 Cometabolic Reductive Dehalogenation**

Some reactions do not contribute to microorganism growth or metabolism. Such reactions, termed cometabolic, may nevertheless result in the fortuitous degradation of contaminants. The cometabolic reductive dehalogenation of chlorinated ethenes is an important example of this type of reaction. In this anaerobic process, a non-specific enzyme acts upon a chlorinated ethene, replacing its chlorine substituent with a hydrogen ion and two electrons (NRC, 2000). For example, PCE (with four chlorine substituents) would be reduced to TCE (with three chlorine substituents). As the transformation of chlorinated ethenes provide no energy to the microorganisms, metabolic electron acceptors such as nitrate or carbon dioxide are required for ATP production.

Biodegradable organic materials, such as natural organic matter or petroleum hydrocarbons, act as the necessary electron donors (Wiedemeier, 1996).

Cometabolic reductive dehalogenation often fails to completely reduce PCE and TCE to ethene. This is due to several factors. First, the chlorinated solvents must compete with the metabolic electron acceptors for available enzyme sites. This is referred to a competitive inhibition. As the solvents only gain a small share of the available electrons, a typical aquifer is depleted of electron donors well before the contaminants are reduced to ethene. Only aquifers co-contaminated with landfill leachate or petroleum hydrocarbons see significant reductive dehalogenation. Second, the solvents or their daughter products may be toxic to some organisms, thereby negatively affecting some microbe

populations (Azadpour-Keeley et al., 1999). Third, daughter products with fewer chlorine substituents are less oxidized, and therefore tend to be reduced less quickly, if at all. This results in the accumulation of cis-DCE and VC (Major et al., 1991; Wilson et al., 1995), which is especially problematic in that VC is more toxic than PCE or TCE (Masters, 1997). For these reasons, cometabolic reductive dehalogenation is “considered ubiquitous in anaerobic systems but generally incapable of mediating complete reduction to non-toxic products like ethene” (Bradley, 2000).

#### **2.2.2.2.2 Reductive Dehalogenation Through Halorespiration**

It has been recently discovered that not all reductive dechlorination processes are cometabolic. A group of microorganisms, called halorespirers, have been found to generate ATP by using chlorinated ethenes as sole terminal electron acceptors (Holliger et al., 1993; Maymo-Gatell et al., 1997). As these microorganisms derive energy from the process, under the appropriate conditions they are capable of higher rates of dechlorination than cometabolizers (Bradley, 2000). Indeed, according to Wiedemeier et al. (1999), halorespiration “probably accounts for the majority of chlorinated solvent biodegradation at many of the sites where biodegradation is significantly attenuating the [chlorinated solvent] plume.” However, the electron donors that are used by halorespirers are limited to hydrogen and possibly acetate and formate. As sulfate reducers, methanogens, and homoacetogens also compete for these electron donors, the ability of halorespirers to reduce VC to ethene may be significantly diminished (McCarty, 1996; Smatlak et al., 1996).

#### **2.2.2.2.3 Cometabolic Oxidation**

As more chlorine substituents are removed and the compound becomes more reduced, the chlorinated ethene may be more easily oxidized. A number of microorganisms have been identified that can oxidize TCE and its daughters (but not PCE) to CO<sub>2</sub> cometabolically (McCarty and Semprini, 1994). This may be an important process when oxygen and the necessary carbon substrate (e.g. methane, ethylene, phenol, toluene) coexist, such as at the fringe of a contaminant plume (Dolan and McCarty, 1995; Anderson and McCarty, 1997).

#### **2.2.2.2.4 Aerobic Oxidation**

In some cases, DCE and VC may be oxidized directly in a process that is beneficial to the microorganisms. In aerobic oxidation, VC can be used as a sole carbon source for growth and metabolism, while DCE has been shown as a carbon substrate for metabolism only. As with cometabolic oxidation, aerobic oxidation may be important at the fringe of a plume (Bradley and Chapelle, 1998b).

#### **2.2.2.2.5 Anaerobic Oxidation**

Anaerobic oxidation is another possible pathway for chlorinated ethene degradation. Microorganisms have been shown to oxidize VC to CO<sub>2</sub> under Fe (III)-reducing conditions. DCE has been shown to oxidize directly to CO<sub>2</sub> under

Mn (IV)–reducing conditions (Bradley et al., 1998). As these processes can take place in an anaerobic environment in conjunction with reductive dehalogenation, this may prove to be a significant pathway for chlorinated ethene degradation.

#### 2.2.2.2.6 Mathematical Description of Contaminant Biodegradation

If there is no shortage of necessary substrates (i.e. electron donors and acceptors) then contaminant degradation can be expressed as a first order decay. That is, the rate at which the contaminant disappears is dependent only upon the contaminant concentration. This is modeled by the equation

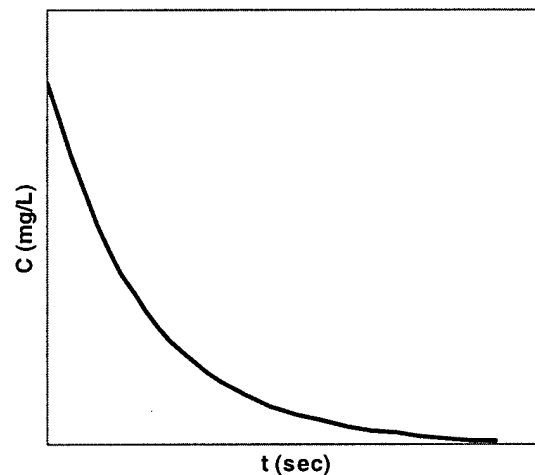
$$\frac{dC}{dt} = -kC \quad (2.4)$$

where

C is the concentration of dissolved contaminant (M/L<sup>3</sup>)

k is the contaminant decay first order rate constant (T<sup>-1</sup>)

Figure 2.4 is an example of a first order process.



**Figure 2.4 First Order Biodegradation**

Reductive dehalogenation is typically modeled as a first order process, with a separate decay constant for each reductive step (Clement et al., 2000). The direct oxidation of chlorinated hydrocarbons is also modeled as first order (Bradley and Chapelle, 1998a).

In situations where one or more substrates limit the rate of biodegradation, it is necessary to use Monod kinetics to describe the rate of the reaction. Monod kinetics describe the growth of microorganisms on a limiting substrate (Suarez and Rifai, 1999) by the hyperbolic saturation function

$$\mu = \mu_{\max} \left( \frac{S}{S + K_s} \right) \quad (2.5)$$

where

$\mu$  = microorganism growth rate ( $T^{-1}$ )

$\mu_{\max}$  = maximum growth rate of microorganisms ( $T^{-1}$ )

$K_s$  = half saturation constant ( $M/L^3$ )

$S$  = concentration of limiting substrate ( $M/L^3$ )

The half saturation constant is the concentration of limiting substrate at which the microorganisms grow at half the maximum growth rate (Wiedemeier et al., 1999).

Dual - Monod kinetics have been used to describe aerobic cometabolism

(Bouwer and McCarty, 1985), as the concentration of both electron acceptors

and contaminants limit the rate of biodegradation. This model is expressed as

$$\frac{dC}{dt} = -X \cdot k \left( \frac{C}{K_S + C} \right) \cdot \left( \frac{C_A}{K_{S_A} + C_A} \right) \quad (2.6)$$

where

$X$  = concentration of microorganisms active for cometabolism ( $M/L^3$ )

$k$  = maximum utilization rate of cometabolism ( $M/M - T^{-1}$ )

$C$  = concentration of target contaminant ( $M/L^3$ )

$K_S$  = half saturation constant of the target contaminant ( $M/L^3$ )

$C_A$  = concentration of electron acceptor ( $M/L^3$ )

$K_{S_A}$  = half saturation constant of electron acceptor ( $M/L^3$ )

The above model does not take into consideration the competitive inhibition between the electron donor and the contaminant for available enzyme sites. The following modification of (2.6) accounts for this competition (Semprini and McCarty, 1992):

$$\frac{dC}{dt} = -X \cdot k \left( \frac{C}{K_S + C + \frac{K_S \cdot C_D}{K_{S_D}}} \right) \cdot \frac{C_A}{K_{S_A} + C_A} \quad (2.7)$$

where

$C_D$  = electron donor concentration ( $M/L^3$ )

$K_{S_D}$  = half saturation constant of electron donor ( $M/L^3$ )

Note that  $X$ , the concentration of microorganisms found in equations (2.6) and (2.7), also depends upon electron donor and acceptor concentrations. Monod

kinetics can be used to describe this relationship as well, as in the equation proposed by Semprini and McCarty (1991), where dual-Monod kinetics describes growth and Monod kinetics describes decay:

$$\frac{dX}{dt} = -XkY \left( \frac{C_D}{K_{S_D} + C_D} \right) \left( \frac{C_A}{K_{S_A} + C_A} \right) - bX \left( \frac{C_A}{K_{S_A} + C_A} \right) \quad (2.8)$$

where

$k$  = maximum utilization rate of cometabolism ( $M/M - T^{-1}$ )

$Y$  = yield coefficient of biomass produced per substrate used ( $M/M$ )

$b$  = microbial decay rate constant ( $T^{-1}$ )

It is important to note that the above equations are general, and that the set of parameter values used will depend upon the specific oxidation-reduction reaction being modeled. For example, the parameters used to model the reductive dehalogenation of PCE to TCE with sulfate as an electron acceptor will differ from the parameters used to model the reduction of TCE to DCE under methanogenic conditions. Therefore, a model that simulates all relevant processes should be able to track the concentration of multiple electron donors, acceptors, and contaminants, then apply the appropriate parameters as required. Typically, simplifying assumptions are built into models, and multiple donors and acceptors are not tracked. Of the models discussed in the next section, only Bio-Redox accounts for reactions among multiple electron donors and acceptors.

### **2.2.3 Models Relevant to the Simulation of Chlorinated Ethene Natural Attenuation**

There are many models available that may be used to simulate chlorinated ethene fate and transport. To reduce the number of models to be considered in detail, an initial screening was accomplished using several criteria. Due to the time and money available for this research, only completed models that were readily available at little or no cost were considered. As discussed in Chapter 1, this research focuses on the natural attenuation of aqueous phase chlorinated solvents in an aquifer. Accordingly, models that simulated transport in the unsaturated zone, a combination of the saturated and unsaturated zone, or simulated dual-phase flow were rejected. Finally, only those models that were able to simulate the reactive step-wise degradation of chlorinated ethenes were investigated. After this initial screening, four models were examined in some detail: Biochlor, Bio-Redox, RT3D, and BR3D.

#### **2.2.3.1 Biochlor**

Biochlor is described as a "natural attenuation decision support system" (Aziz et al., 2000) for sites with dissolved chlorinated solvents. This computer code provides concentration data along the plume centerline by describing one-dimensional (1-D) advection, three-dimensional (3-D) dispersion, linear sorption, and biotransformation due to reductive dehalogenation (Aziz et al., 2000). The biotransformation process is modeled as a sequential first order decay, and two separate reaction zones can be simulated.



Biochlor is a screening model that assumes simple groundwater flow, uniform hydrogeologic and environmental conditions, and a constant vertical plane source (Aziz et al., 2000). The purpose of this model is to facilitate remediation planning, and it is not designed to accurately predict contaminant concentrations in a complex, real aquifer.

#### **2.2.3.2 Bio-Redox**

Bio-Redox is a comprehensive 3-D model used to simulate multiple oxidation-reduction reactions (Feng, 2000). The model describes 3-D advection and dispersion, linear and non-linear equilibrium sorption, but not rate-limited sorption. Bio-Redox can simulate contaminant biotransformation due to reductive dehalogenation, direct oxidation, or methanotrophic cometabolism by using either first order, Monod, Dual-Monod kinetics (with and without competitive inhibition). This computer code can simulate reactions among multiple electron donors and acceptors, and can track the accumulation of chloride ions released by reductive dehalogenation. As the application of Bio-Redox to a site does not require any modification of the FORTRAN source code, the program is relatively simple to use.

#### **2.2.3.3 RT3D**

**Reactive Multi-species Transport in 3-Dimensions**, otherwise known as RT3D, simulates multiple transport equations coupled with multiple biochemical kinetics (Clement, 2000). RT3D is a modular program, composed of subprograms that allow the modeler to describe 3-D advection and dispersion; sorption through

linear equilibrium, non-linear equilibrium, or rate limited reactions; and biodegradation through first order, Monod, or Dual-Monod kinetics. The modular design of RT3D makes it highly adaptable to a specific site; seven preprogrammed modules are available, and modelers can create their own module to run within the program. While RT3D's design allows for great flexibility and creativity in applying the model to a site, the level of effort required is considerable. The appropriate reaction module must be chosen (Clement, 1997) and correctly placed within the FORTRAN source code, a task that is difficult due to the code's complexity (Feng, 2000). The unintentional modification of source code is also of concern.

#### **2.2.3.4 BR3D**

BR3D is a model developed at the Air Force Institute of Technology (AFIT) to simulate the degradation of chlorinated ethenes through the cometabolic processes of reductive dechlorination and aerobic oxidation. The capabilities of BR3D are similar to RT3D in that it can simulate 3-D advection and dispersion; sorption through linear equilibrium, non-linear equilibrium, or rate limited reactions; and biodegradation through first order, Monod, or Dual Monod kinetics. It cannot combine multiple electron acceptors and donors in oxidation-reduction processes (Feng, 2000). BR3D is relatively easy to use, as it does not require modification of the FORTRAN source code.

## 2.3 Model Validation

There is no single definition of the term “validation” within the scientific community (Leijnse and Hassanizadeh, 1994). The International Atomic Energy Agency, an entity that supervises the development of many long-term predictive models, defines validation in the following manner (IAEA 1982):

A conceptual model and the computer code derived from it are validated when it is confirmed that the conceptual model and the computer code provide a good representation of the actual processes occurring in the real system.

Schlesinger (1979) provides a similar definition, stating that validation is

Substantiation that a computerized model within its domain of applicability possesses a satisfactory range of accuracy consistent with the intended application of the model.

A considerable number of arguments about model validation are centered on the scope of the validation effort. Sargent (1982) states that validation consists of three components: validation of the logic and consistency of the model (conceptual validation); determination of the model’s ability to answer the question at hand (operational validation); and comparison of the simulation to the observed system (quantitative validation). Others argue that validation only consists of the comparison of model output to independent observations (McCombie and McKinley, 1998; ASTM, 1996; USEPA, 1989). For the purposes of this work, the overarching concept of building confidence in a model’s predictive capability will be referred to as model *validation*, while the specific task of comparing model output to independent observations will be termed *comparative analysis*.

In a strict sense, no model can ever be considered true (i.e. valid) under all circumstances (Tsang, 1991). In accordance with the scientific method, a hypothesis can be proved 'false' or 'not false,' but may never be considered 'true,' 'valid,' or 'substantiated' (Popper, 1959; Konikow, 1992; Bredehoeft and Konikow, 1993). However, Niederer argues that "it does not make sense to demand strict proof that a model is correct; it makes a lot of sense, however, to promote consensus by providing ample positive evidence for the correctness of the model. In this sense, validation is primarily a means to achieve consensus" (Niederer, 1990). In order to build consensus that a model accurately describes important processes, the structure of the model itself should be verified, and its application to a particular problem should be validated through model calibration and comparative analysis of model output to observed conditions.

### **2.3.1 Model Verification**

A model's structure is verified through an extensive process of documentation and testing of the computer code. Documentation of a computer code begins with the development of the algorithms and procedures, and continues throughout the modeling process (ASTM, 1996). This allows others to check the accuracy of the code as well as understand the assumptions upon which the model is based. Computer code verification is "the process of demonstrating the consistency, completeness, correctness, and accuracy of a ground-water modeling code with respect to its design criteria by evaluating the functionality

and operational characteristics of the code and testing embedded algorithms and internal data transfers through execution of problems for which independent benchmarks are available” (ASTM, 1996). Analytical results or results from a known data set are common independent benchmarks used to ensure that the computer code is performing as expected (Clement et al., 2000). A computer code is verified when it is determined to be “mathematically correct in the formulation and solution” (Tsang, 1991).

### **2.3.2 Model Calibration**

Model verification is no guarantee that the assumptions and processes simulated in a model are applicable to a given real system. To show that the model can represent such systems requires model calibration. Calibration is the process of adjusting model parameters, initial and boundaries conditions, and stresses so that the model approximates field-measured values (Levy, 1993). Calibration is an important step in model validation, as it can uncover flaws in the design and implementation of the model. According to the NRC, “if the model cannot capture the observed trends no matter how well it is calibrated, then its conceptual basis surely is wrong” (NRC, 2000). Calibration is particularly useful when necessary parameter values are unavailable or difficult to obtain. The standard calibration procedure seeks to minimize the differences between observed and predicted behavior, as measured by some goodness-of-fit statistic (Armstrong et al., 1996). Parameter values that optimize the goodness-of-fit statistic can be determined through the use of nonlinear regression analysis (Hill,

1998), or through a trial-and-error, forward process (Levy, 1993; Resele and Job, 1990). Mean squared error (MSE) is a commonly used goodness-of-fit statistic, and will be discussed in later sections. Hill (1998) uses nonlinear regression in the computer program UCODE to optimize the parameter values ( $P'_p$ ) by minimizing the following statistic:

$$S(\underline{b}) = \sum_{i=1}^{ND} \omega_i [Q_{O_i} - Q_{S_i}]^2 + \sum_{p=1}^{NPR} \omega_p [P_p - P'_p]^2 \quad (2.9)$$

where

$\underline{b}$  = a vector with values for each of the NP parameters being estimated

ND = number of observations

NPR = number of independently estimated parameter values

NP = number of estimated parameters ( $NP \geq NPR$ )

$Q_{O_i}$  =  $i^{\text{th}}$  observation

$Q_{S_i}(\underline{b})$  = simulated value corresponding to the  $i^{\text{th}}$  observation

$P_p$  =  $p^{\text{th}}$  independently estimated parameter value

$P'_p$  =  $p^{\text{th}}$  fitted parameter value

$\omega_i$  = weight for the  $i^{\text{th}}$  observation

$\omega_p$  = weight for the  $p^{\text{th}}$  independently estimated parameter

Weighting performs two functions (Hill, 1998). First, the weights ensure that the weighted residuals have the same units so that they may be squared and summed as shown in equation (2.9). Second, the weights determine the amount of influence an observation or independently estimated parameter value has. As

the weights are based on the uncertainty of the measurement, more accurate estimates and observations will have greater influence on the overall statistic.

The benefit of this statistic is that it penalizes those models whose fitted parameter values differ significantly from independently estimated values. Parameter values should be chosen carefully if such a penalty is not incurred, as it is possible to obtain an excellent fit between predicted and observed results using unrealistic parameter values (Bobba, 1993). To prevent this, parameter values used in a model are typically bounded to values that are deemed realistic based on sound judgment (Bobba, 1993) or by the literature (Clement et al., 2000).

Some models require no calibration, as they are used in a purely predictive manner (Eggleston, 2000; Bond, 1998; Armstrong, 1996). That is, the input parameter values are derived independently from field and lab experiments or from the relevant literature. These models tend to be relatively simple models, such as pesticide leaching models or simplified groundwater flow models, and can be difficult to use when parameters values cannot be easily obtained (Clement, 2000). According to the NRC (2000), any comprehensive reactive transport model must be calibrated.

Not all parameter values used in a comprehensive model have to be determined exclusively by calibration. Through the use of geostatistical methods such as

kriging, parameter values such as hydraulic conductivity may be estimated. This method can provide a more independent representation of the real system.

### **2.3.3 Comparative Analysis**

Once a model has been calibrated, simulations can be run and compared to additional laboratory or field data outside the calibration set. According to the EPA (1989), “field evaluations of models often lead to a better understanding of the processes taking place and point to additional research needs.” This research will compare model results to field observations. Comparing model results to field observations has been referred to as groundtruth model testing (Ababou et al., 1992) or model validation (McCombie and McKinley, 1998; ASTM, 1996; USEPA, 1989). For the purposes of this research, such an evaluation will be called a *comparative analysis*. Comparative analysis can be divided into two categories: qualitative comparative analysis and quantitative comparative analysis.

#### **2.3.3.1 Qualitative Comparative Analysis**

Qualitative comparative analysis is a common means to build consensus that a model is simulating the processes taking place in the field. In the realm of groundwater contaminant fate and transport modeling, model output is typically compared to field observations through the use of concentration plots. Examples of such comparisons include contaminant breakthrough curves and two-dimensional concentration contour plots. While this method allows for a concise



and informative study of the model's performance, it has its drawbacks. Most notably, qualitative methods are subjective in nature, which makes it difficult to compare results between two or more models. To overcome this drawback, it is recommended that qualitative methods be combined with quantitative methods to produce the most comprehensive description of model performance (Willmott, 1984; Legates and McCabe, 1999).

### **2.3.3.2 Quantitative Comparative Analysis**

Just as there is no one definition of validation, there is also no one best statistic to determine the goodness-of-fit between observations and model output (Weglarczyk, 1998; Imam et al., 1998). Accordingly, various combinations of statistical measures are used to evaluate models (Legates and McCabe, 1999; Imam et al., 1998). One of the main purposes of this research is to choose a combination of statistics that can be used to evaluate the goodness-of-fit of a model simulation. This section will discuss the residual-based and association-based statistics that may be suitable to measure model goodness-of-fit.

One method of quantifying model performance is to calculate the summation of all the differences, or residuals, between the simulated values ( $Q_S$ ) and their corresponding observed values ( $Q_O$ ). Common residual-based statistics include bias (B), sum of squares error (SSE), and mean squared error (MSE).

Bias is a measure of the systematic error associated with a model (Devore, 1995). The amount that a model consistently overestimates or underestimates

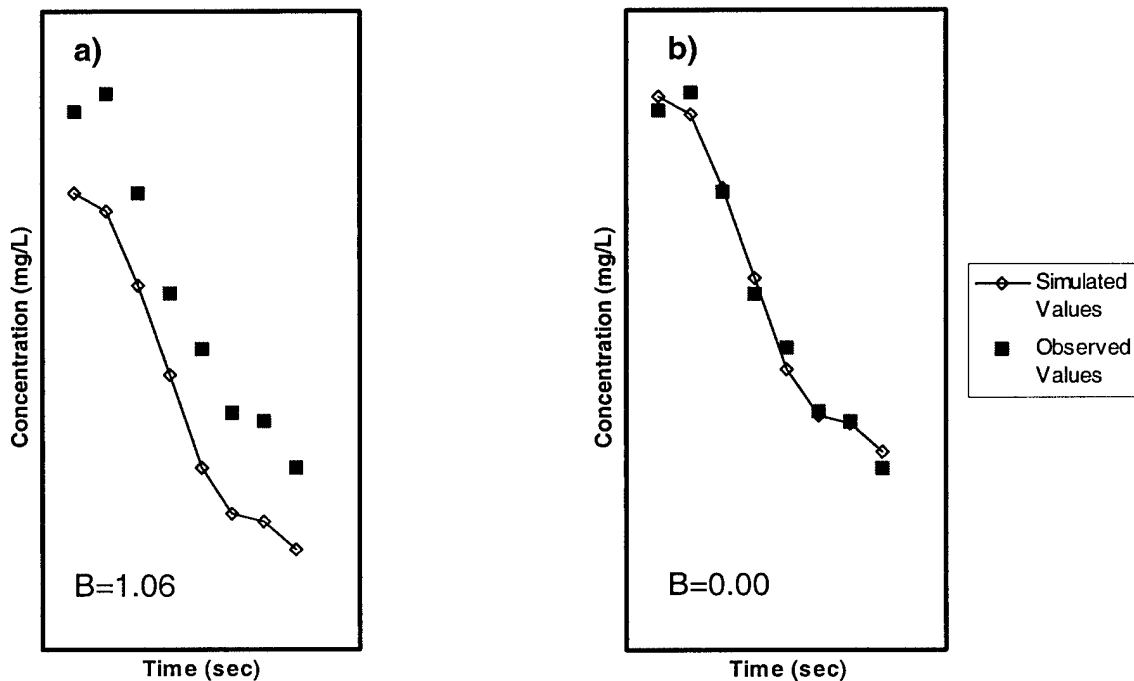
the values of interest is reflected in the calculation of bias. Figure 2.5 illustrates the difference between biased and unbiased models. Unconditional bias (B), is defined as

$$B = m_s - m_o \quad (2.10)$$

where

$m_s$  = average simulated value

$m_o$  = average observed value



**Figure 2.5 Example of a Model a) with Bias, and b) without Bias**

If a nondimensional measure of bias is preferred,  $B'^2$  can be used (Weglarczyk, 1998).  $B'^2$  is defined as

$$B'^2 = \frac{B^2}{s_o^2} \quad (2.11)$$

where

$s_o$  = standard deviation of the observed values

Conditional bias ( $C^2$ ), another measure of model performance, is the measure of covariance between model residuals ( $Q_s - Q_o$ , or  $\Delta Q$ ) and simulated values ( $Q_s$ ), and is defined as

$$C^2 = \text{cov}(Q_s - Q_o, Q_s) = s_s^2 - \overline{Q_o Q_s} - m_o m_s \quad (2.12)$$

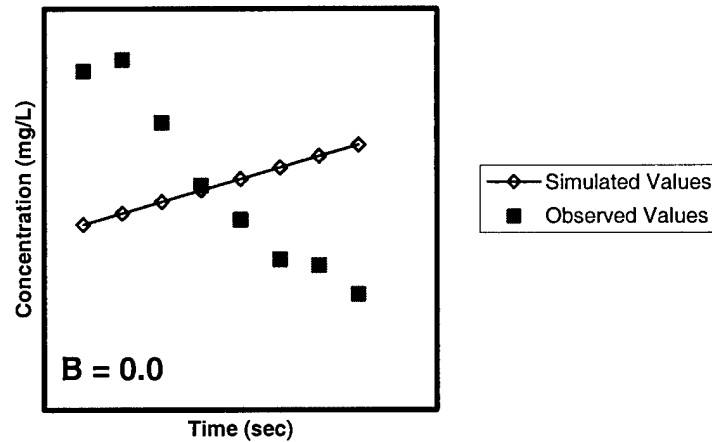
where

$s_s$  = standard deviation of the simulated values

Note that the overline indicates the average of the quantities indicated.

Covariance, an association-based statistic, will be discussed in detail later in this section. A completely unbiased model will have values of  $B$ ,  $B'^2$ , and  $C^2$  equal to zero. The relationship between the  $B'^2$ , and  $C^2$ , and other statistics will also be discussed in later paragraphs.

A model may be perfectly unbiased but still be unacceptable in terms of matching simulated values to observed values. Large overestimates may be balanced by large underestimates, as shown in Figure 2.6. Statistics that sum the square of errors or the absolute errors are required to better assess overall model performance. Calculations of this nature include sum of squares error (SSE), mean absolute error (MAE), and mean squared error (MSE).



**Figure 2.6 Unbiased Model that Fails to Match Observed Data**

Sum of squares error is defined as

$$SSE = \sum (Q_o - Q_s)^2 \quad (2.13)$$

Mean absolute error is another familiar residual-based statistic, and is defined as

$$MAE = \overline{|Q_o - Q_s|} \quad (2.14)$$

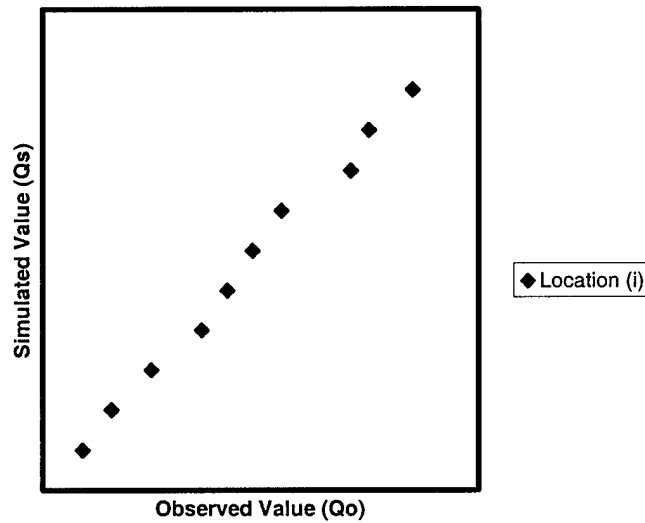
Even more commonly used is the statistic mean squared error, which is shown as

$$MSE = \overline{(Q_o - Q_s)^2} \quad (2.15)$$

Root mean square error (RMSE), the square root of MSE, is also used frequently as it has the same units as the residuals. RMSE has been used extensively as an objective function in model calibration (Sorooshian et al., 1983), while MSE is commonly used in meteorological forecast validation (Wilks, 1995). Fox (1981) and Willmott (1982) consider RMSE to be among the best residual-based performance measures. However, as both MSE and RMSE are calculated with squared differences, they are overly sensitive to extreme values (Legates and McCabe, 1999). Additionally, MSE and RMSE are cumbersome to use when

comparing the performance of different models, as their values are dependant upon the units of the observations and simulations. As a result of this dimensionality, the MSE of a model that is simulating data measured in milligrams per liter (mg/L) would differ significantly from a model that simulates data measured in moles per liter (mol/L). Non-dimensional statistics (discussed later in this section) should be used along with MSE and RMSE in order to quantify model goodness-of-fit (Legates and McCabe, 1999).

Residual-based statistics such as MSE are often used in conjunction with association-based statistics to provide the modeler with a comprehensive measure of model quality. To best understand association-based statistics, consider the scatter plot in Figure 2.7. Each point represents a measured and simulated value at a certain location or time. The x-coordinate of each point is determined by the observed value ( $Q_o$ ), while the simulated value ( $Q_s$ ) determines the y-coordinate. Association-based statistics quantify the correlation, or strength of the linear relationship, between the predicted and observed values. It should be pointed out that this is not the same as regression, which implies a causal relationship between independent and dependent variables. Covariance (cov), sample correlation coefficient ( $r$ ), coefficient of determination ( $R^2$ ), and coefficient of efficiency ( $E$ ), are commonly used association-based statistics.



**Figure 2.7 Plot of Simulated and Observed Values**

Covariance measures the strength of the relationship between the observed and simulated values, and is defined as

$$\text{cov}(Q_o, Q_s) = \overline{Q_o Q_s} - m_o m_s \quad (2.16)$$

where

$Q_o$  = observed values

$Q_s$  = simulated values

$m_s$  = average simulated value

$m_o$  = average observed value

As with MSE, covariance is unwieldy due to its dimensionality. To overcome this, the nondimensional measure of covariation,  $r$ , can be used.  $r$ , known as the Pearson's product-moment correlation coefficient (Legates and McCabe, 1999), is defined by Weglarczyk (1998) as

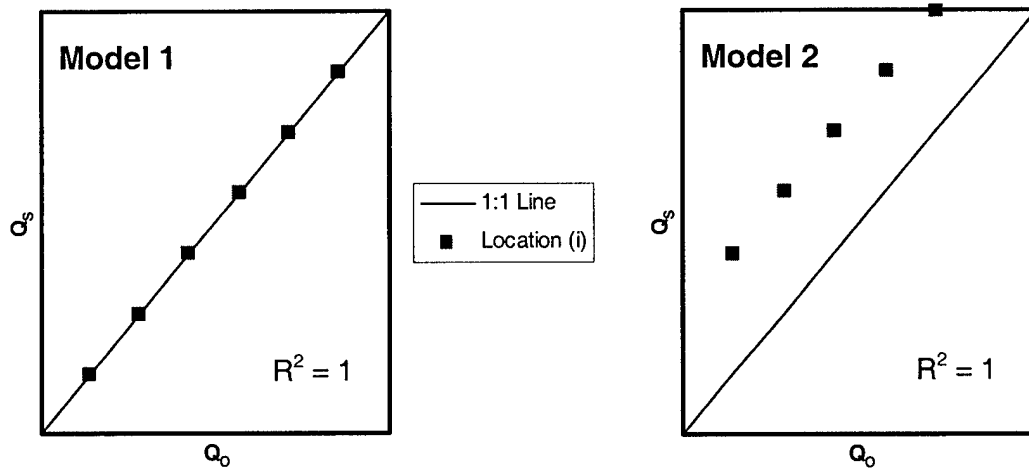
$$r = \frac{\text{cov}(Q_o, Q_s)}{s_o s_s} = \frac{\overline{Q_o Q_s} - m_o m_s}{s_o s_s} \quad (2.17)$$

where

$s_o$  = standard deviation of the observed values

$s_s$  = standard deviation of the simulated values

The Pearson's correlation coefficient is bounded from  $-1$  (the largest negative correlation) to  $1$  (the largest positive correlation). A more common measure of correlation is  $R^2$ , the coefficient of determination.  $R^2$  is calculated as the square of the sample correlation index ( $R^2 = r^2$ ) and describes the total variance in the observed data that can be explained by a linear model of correlation. A value of  $R^2 = 1$  is achieved when all points lie along a straight line (Devore, 1995). It is important to note that  $R^2$  "estimates the concentration of  $[(Q_o, Q_s)]$  points along an arbitrary line on the  $[(Q_o, Q_s)]$  plane, not along the 1:1 line which is of the only interest to the modeller" (Weglarczyk, 1998). This point is illustrated in Figure 2.8, where two modeling results are displayed. The value of  $R^2$  is the same for both models, but Model 2 clearly overestimates the observed results, as denoted by the 1:1 line. Due to the insensitivity of  $r$  and  $R^2$  to bias, it has been argued that neither should be used as a measure of model performance (Legates and McCabe, 1999; Fox, 1981; Willmott, 1981; 1984).



**Figure 2.8 Insensitivity of Sample Correlation Coefficient to Bias**

One association-based statistic that does account for model bias is the Nash-Sutcliffe coefficient of efficiency,  $E$ . The coefficient of efficiency is an estimate of the concentration of  $(Q_o, Q_s)$  points along the 1:1 line, or line-of-perfect-fit. The coefficient of efficiency is also related to the coefficient of determination by the relationship

$$E = R^2 - C^2 - B'^2 \quad (2.18)$$

The coefficient of efficiency can also be calculated as a dimensionless transformation of MSE, and is defined by

$$E = 1 - \frac{\text{MSE}}{s_o^2} \quad (2.19)$$

The Nash-Sutcliffe coefficient has several desirable characteristics. First, this coefficient is nondimensional, making it easier to compare the performance of different models. Second,  $E$  is a measure of the departure of the  $(Q_o, Q_s)$  values from the line-of-perfect-fit, which is highly relevant to modelers. Finally, the coefficient of efficiency increases as model goodness-of-fit increases. A



maximum value of  $E = 1$  suggests perfect model performance, while a negative value of  $E$  indicates that the model “introduces more ambiguity than that introduced by simply using the mean value of the observation as an estimator” (Imam et al., 1999). While  $E$  is a useful goodness-of-fit statistic, it is more difficult to interpret than  $R^2$ . According to Legates and McCabe (1999), an  $E$  of 0.70 means that the mean square error accounts for 30% of the variance in the observed data. Frankenberger et al. (1999) describe  $E$  in terms of mean observation values, such that an  $E$  of 0.70 indicates that the model performs 70% better than simply using the average value of the observation. In validating watershed prediction models that have been calibrated, Arnold et al. (1997) term values of  $E$  greater than 0.70 as “a reasonable fit,” while Micovic and Quick relate that values of  $E$  greater than 0.80 are “quite satisfactory.” For models that do not require major calibration, Frankenberger et al. (1999) considered values of  $E$  near 0.60 to be “good”.

While it is recognized that no one calculation is capable of quantifying model goodness-of-fit, a combination of the above statistics should be useful. Legates and McCabe (1999) suggest that a statistical assessment of model performance should include both absolute measures of error (e.g.  $B$ , RMSE) and relative measures of error (e.g.  $E$ ,  $B'^2$ ). Previous use of statistics in the context of reactive transport model validation will be discussed in the following section.

## **2.4 Case Studies Using Models to Simulate the Natural Attenuation of Chlorinated Solvents**

Several recent field studies have focused on monitored natural attenuation as a viable containment technology for chlorinated solvent plumes. Almost all of these studies have incorporated reactive transport modeling in order to demonstrate that natural attenuation has taken place. These modeling efforts typically involve some level of model validation in order to convince regulators, scientists, and the general public that the application of the model was sound. This section will review field studies in the literature that include model calibration, quantitative comparative analysis, or qualitative comparative analysis as a means of model validation.

Model calibration is the most oft-performed validation technique. One of the best examples of a reactive transport model calibration can be found in the study performed at the Area-6 site on Dover Air Force Base, Delaware (Clement et al., 2000). RT3D was used in conjunction with the groundwater flow code MODFLOW to simulate chlorinated ethene fate and transport. Hydrogeologic parameter values were determined through tracer tests or from relevant literature, and contaminant source loading was quantified through model calibration. Model calibration was performed in a trial-and-error process to fit the concentration profiles observed in 1997 for PCE, TCE, cis-DCE, VC, ethene, and chloride. Similar calibration studies include those performed by Swanson (1999) at Site CCFTA-2 at Cape Canaveral, Florida using MODFLOW and MT3D; Moutoux and Hicks (1999) at Building 301 at Offutt Air Force Base, Nebraska

using MODFLOW and MT3D; Carey et al. (1999) at Site FT-002 at Plattsburgh Air Force Base, New York using MODFLOW and BIOREDOX; Barton et al. (2000) at site FTP at Naval Air Station Fallon, Nevada using MODFLOW and RT3D; Mason et al. (2000) at Naval Air Engineering Station Lakehurst, New Jersey using MODFLOW and RT3D.

In many of the previously discussed studies, the calibrated model was used to predict future contaminant concentration profiles in order to support decisions on the use of monitored natural attenuation. The value of these predictions, however, is uncertain, as predictions were not tested against observations. Although the models were calibrated, there was no assurance that the models would perform adequately outside the calibration data set. Indeed, a study of groundwater flow model calibrations revealed that “good calibration does not lead to good prediction” (Freyberg, 1988). This reemphasizes the importance of performing comparative analysis between predictions to observations. While examples can be found in the realm of weather forecasting (Wilks, 1995), pesticide leaching modeling (Bond, 1998), and groundwater flow modeling (Lee and Ketelle, 1988; Anderson, 1992; Bobba, 1993; Osei, 1995; Eggleston and Rojstaczer, 2000), no documented studies involving chlorinated ethene fate and transport modeling were found that performed comparative analysis between simulations and observations beyond model calibration. If such an analysis were to be accomplished, sufficient data would be required to support both model calibration and comparative analysis. Field sites that could support such a

demand for data include Site FTP at Naval Air Station Fallon, Nevada (Barton et al., 2000) and Site LF-01 at Warren Air Force Base, Wyoming (Parsons Engineering Science, 1999).

## **3.0 Methodology**

### **3.1 Overview**

In this chapter, we present a methodology for validating a model that simulates natural attenuation of chlorinated ethenes. To demonstrate this methodology, we will first choose a fate and transport code that simulates the important aquifer processes thought to be occurring at Site LF-03 at F. E. Warren Air Force Base, Cheyenne, Wyoming. Second, the code will be calibrated to site data, and the calibrated fit will be evaluated through the inspection of concentration contour plots and goodness-of-fit statistics. Third, the calibrated site model will be used to perform a predictive simulation. Lastly, the simulation data will be compared to the data from Site LF-03 using the same evaluation tools (e.g. goodness-of-fit statistics) employed to evaluate calibration. It is hoped that this methodology will increase confidence in our ability to simulate natural attenuation of chlorinated ethenes, as well as provide a greater understanding of natural attenuation processes occurring at a particular site.

### **3.2 Code Selection**

#### **3.2.1 Characteristics of the Site**

In order to select an appropriate computer code to simulate conditions at Site LF-03, it is necessary to have a conceptual model of the site. In this section, we briefly characterize the site, to include a description of the military base, the

landfill under investigation, and the subsurface processes thought to be taking place near that landfill.

F. E. Warren Air Force Base (Warren AFB), adjacent to the city limits of Cheyenne, Wyoming, has been a military post since 1867. The Air Force assumed control of the installation in 1947, and has used the base to support both training and operational commands. Warren AFB is currently the home of Air Force Space Command's 90<sup>th</sup> Space Wing, a unit responsible for the readiness and maintenance of intercontinental ballistic missiles (ICBMs).

Landfill 03 (LF-03) was operational on Warren AFB from approximately the mid-1950's to the mid-1960's for the disposal of industrial and residential wastes generated by the base (Parsons Engineering Science, 1999). LF-03 is located in the southeast corner of the base, is approximately 7 acres in area, and contains a maximum of 15,400,000 cubic ft (ft<sup>3</sup>) of fill. In the mid 1980's it was determined that leachate from LF-03 could possibly pose a threat to human health and the environment. Groundwater monitoring wells were installed and sampled in 1987 and 1988. After Warren AFB was placed on the National Priorities List (NPL) in February of 1990, a 1991 remedial investigation (RI) revealed that TCE was the primary groundwater contaminant. It was hypothesized that TCE, used as a metal cleaner at base shops, had been disposed in LF-03 according to the standard industry practices of the day. A focused RI was started for LF-03 in 1995, and a treatability study to evaluate the use of monitored natural attenuation

(MNA) was conducted by Parsons Engineering Science and the USEPA National Risk Management Research Laboratory (NRMRL) in 1999.

The treatability study indicated that several processes were taking place in the aquifer. First, it suggested that anaerobic conditions near the source area (caused by the degradation of co-contaminants) allowed for the reductive dechlorination of TCE. Several lines of evidence supported this claim, including the presence of cis-1,2-DCE. As DCE was not used in the base shops, the most likely source of this contaminant is from the reduction of TCE. Second, it was suggested that DCE and VC were being oxidized downgradient of the source. The most convincing evidence for this theory was the increasing ratio of TCE to DCE found downgradient of the landfill. This led to the hypothesis that "DCE is degraded through oxidation reactions, while TCE mass is relatively unaffected by destructive attenuation mechanisms" (Parsons Engineering Science, 1999).

Oxygen, present in significant concentrations downgradient of the source, is assumed to be the electron acceptor in the oxidation reactions. Unfortunately, there are insufficient oxygen data to model direct oxidation of DCE and VC. As a result, it will be assumed that the attenuation of all chlorinated ethenes is the result of first-order reductive dehalogenation.

Assumptions are also made about the sorption process. Following the treatability study (Parsons Engineering Science, 1999), sorption is assumed to be an equilibrium process. The linear sorption model is also deemed appropriate for

this site, as the concentration of contaminants is relatively low throughout the area under study. Based on these assumptions, any computer code chosen for this research should be able to simulate linear equilibrium sorption and reductive dehalogenation of chlorinated ethenes.

### 3.2.2 Criteria for Code Selection

When deciding which computer code to apply to a site, the most important consideration is that “the processes identified as being important at the site must correspond to those included in the model” (Weaver et al., 1987). The computer code’s ability to model a relevant process is known as an essential code capability, in that “if a candidate code does not include the essential capabilities, it should be removed from consideration” (ASTM, 1997). Due to the complex flow characteristics found at Site LF-03 (Parsons Engineering Science, 1999), it was decided that a 3D transport model was necessary to represent the site. 3D representation is considered an essential code capability, as is the ability to represent linear equilibrium sorption and anaerobic reduction. Table 3.1 compares essential code capabilities against the capabilities of the candidate codes.

<b>Essential Code Capabilities</b>	<b>Biochlor</b>	<b>Bio-Redox</b>	<b>BR3D</b>	<b>RT3D</b>
<b>Physicochemical Processes</b>				
3-D Advection	No	Yes	Yes	Yes
3-D Dispersion	Yes	Yes	Yes	Yes
Linear Equilibrium Sorption	Yes	Yes	Yes	Yes
<b>Biological Processes</b>				
Anaerobic Reduction of chlorinated ethenes	Yes	Yes	Yes	Yes

**Table 3.1 Essential Capabilities of Candidate Codes**



Based upon the essential code capabilities, only Bio-Redox, BR3D, and RT3D will be considered for further study.

Model selection also depends upon non-essential code capabilities, such as ease of use and code credibility. These capabilities are subjectively ranked, in order of decreasing relative importance, by the modeler. This ranking process allows a balance to be struck between modeling effort and results obtained (ASTM, 1997). Table 3.2 contains a list of preferred attributes on which the candidate codes can be judged. The ability of each program to meet designated non-essential capability is ranked Good, Fair, or Poor. User Support and Ease of Use are relatively important in this effort due to the experience of the modeler and the time available in the study. As this research will attempt to build confidence in the code's application to the site, attributes such as Code Acceptance and Code Credibility are less important.

<b>Non-Essential Code Capabilities</b>	<b>Bio-Redox</b>	<b>BR3D</b>	<b>RT3D</b>
User Support	Poor	Good	Poor
Ease of Use (data input/output)	Poor	Poor	Poor
Code Documentation	Poor	Poor	Good
Code Availability	Good	Good	Good
Code Acceptance	Good	Poor	Good
Code Credibility	Good	Poor	Good

**Table 3.2 Non-Essential Capabilities of Candidate Codes**

### **3.2.3 Code Selected to Represent Site LF-03**

Of the codes inventoried in Chapter 2, BIOREDOX, RT3D, and BR3D are able to perform the essential calculations required to represent the physicochemical and biological processes thought to be occurring at Site LF-03. This results in

choosing a computer code based on the non-essential capabilities listed in the previous paragraph. Of these capabilities, the most important is the availability of technical support to the modeler. Based on these criteria, it was decided to use BR3D in the validation studies performed in this research.

### **3.3 Code Application to Site LF-03**

The application of BR3D to Site LF-03 is based upon the treatability study (TS) of MNA performed by Parsons Engineering Science (1999). In the TS, the computer code MT3D was used in conjunction with MODFLOW (a groundwater flow model) to depict the fate and transport of TCE. A 220-cell by 125-cell by three layer model domain was created (see Figure 3.1), with each cell measuring 20 feet by 20 feet. MODFLOW and MT3D were calibrated using data collected from 27 monitoring wells. Simulations were then performed to ascertain the effectiveness of different remedial alternatives. While this modeling study proved informative to decision-makers at Warren AFB, it had several shortcomings. First, TCE was the only contaminant studied, even though DCE and VC were also detected at the site. Second, the study did not involve any effort, outside of model calibration, to validate the application of the model to the site. This research will address these two points specifically by using BR3D to predict TCE, DCE, and VC concentrations, then compare those values to values observed at the site. The remainder of this section will discuss how the groundwater flow model created in the TS was adapted for use in this research, and will describe how the contaminant fate and transport code BR3D was applied to LF-03.

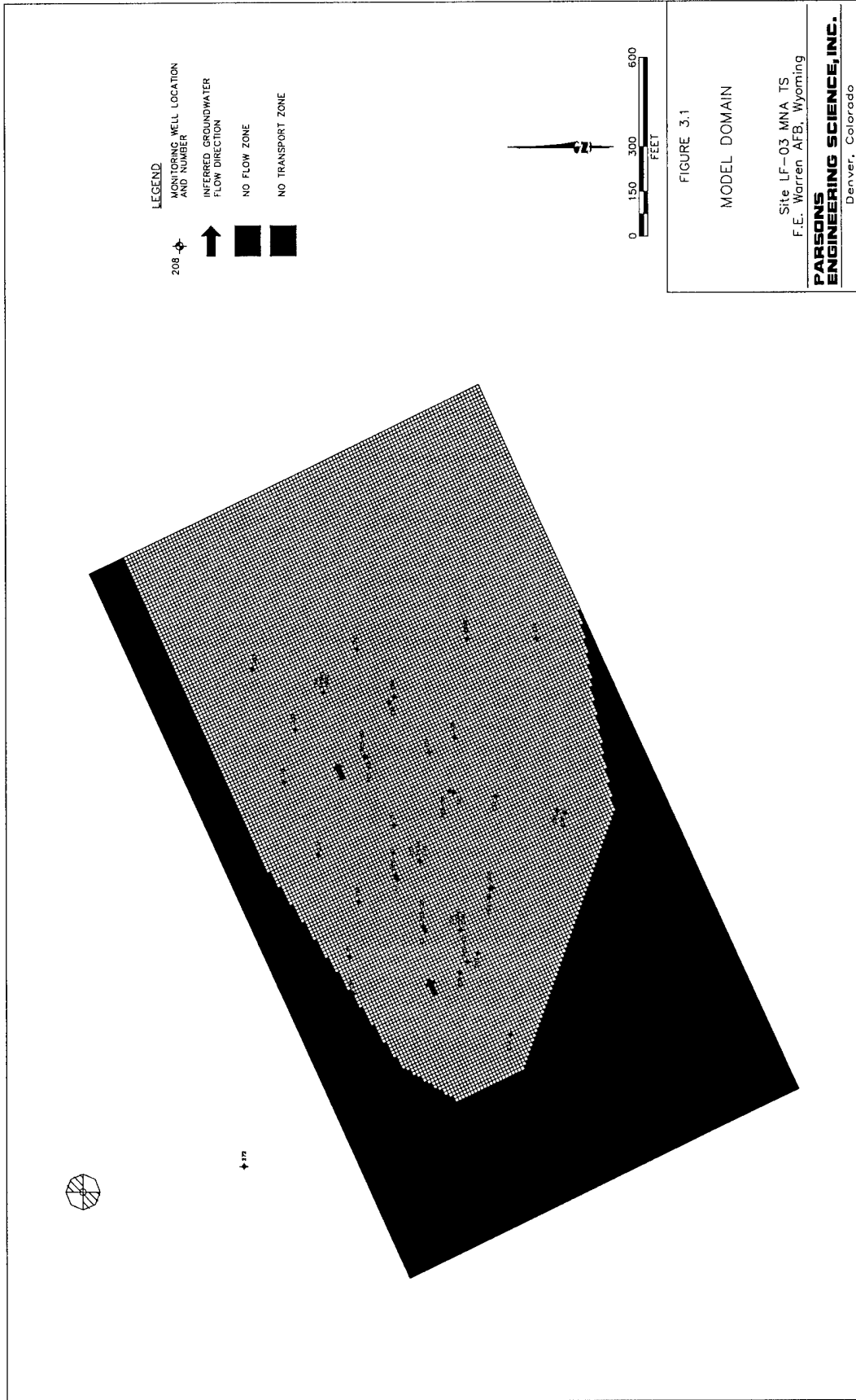


Figure 3.1 Model Domain (after Parsons Engineering Science (1999))

### **3.3.1 Groundwater Flow Model**

Like MT3D, BR3D requires the use of MODFLOW, a groundwater flow code developed by the U.S. Geological Survey (Harbaugh and McDonald, 1996). MODFLOW calculates hydraulic heads and groundwater fluxes, which are then used by fate and transport codes such as MT3D and BR3D to calculate contaminant concentrations. MODFLOW is a highly regarded program, and its extensive use in the study of hydrogeology and contaminant transport bears witness to its usefulness. This research does not attempt to validate the application of MODFLOW to Site LF-03. Instead, the Visual MODFLOW (Version 2.8.2.0) flow model of Site LF-03 (Parsons Engineering Science, 1999) is assumed to be valid for the purposes of this research. The site flow model is based upon reasonable assumptions and a thorough conceptual understanding of the site (Parsons Engineering Science, 1999). Figure 3.2 depicts hydraulic head contours at the site based on measurements taken May 1999. The reported hydraulic mass balance bolsters the assumption of flow model validity; the discrepancy between incoming and outgoing hydraulic flux for the steady-state calibrated flow model was calculated as 0.0 percent (Parsons Engineering Science, 1999). Groundwater flow parameter values that apply to the entire model domain are listed in Table 3.3, while individual cell values can be found in the flow model itself (Parsons Engineering Science, 1999). The average value of hydraulic conductivity depends upon which of the three zones (ungradient, downgradient, or Crow Creek) is under consideration (Table 3.3 and Figure 3.2). As it is assumed that the groundwater flow portion of the model will perform

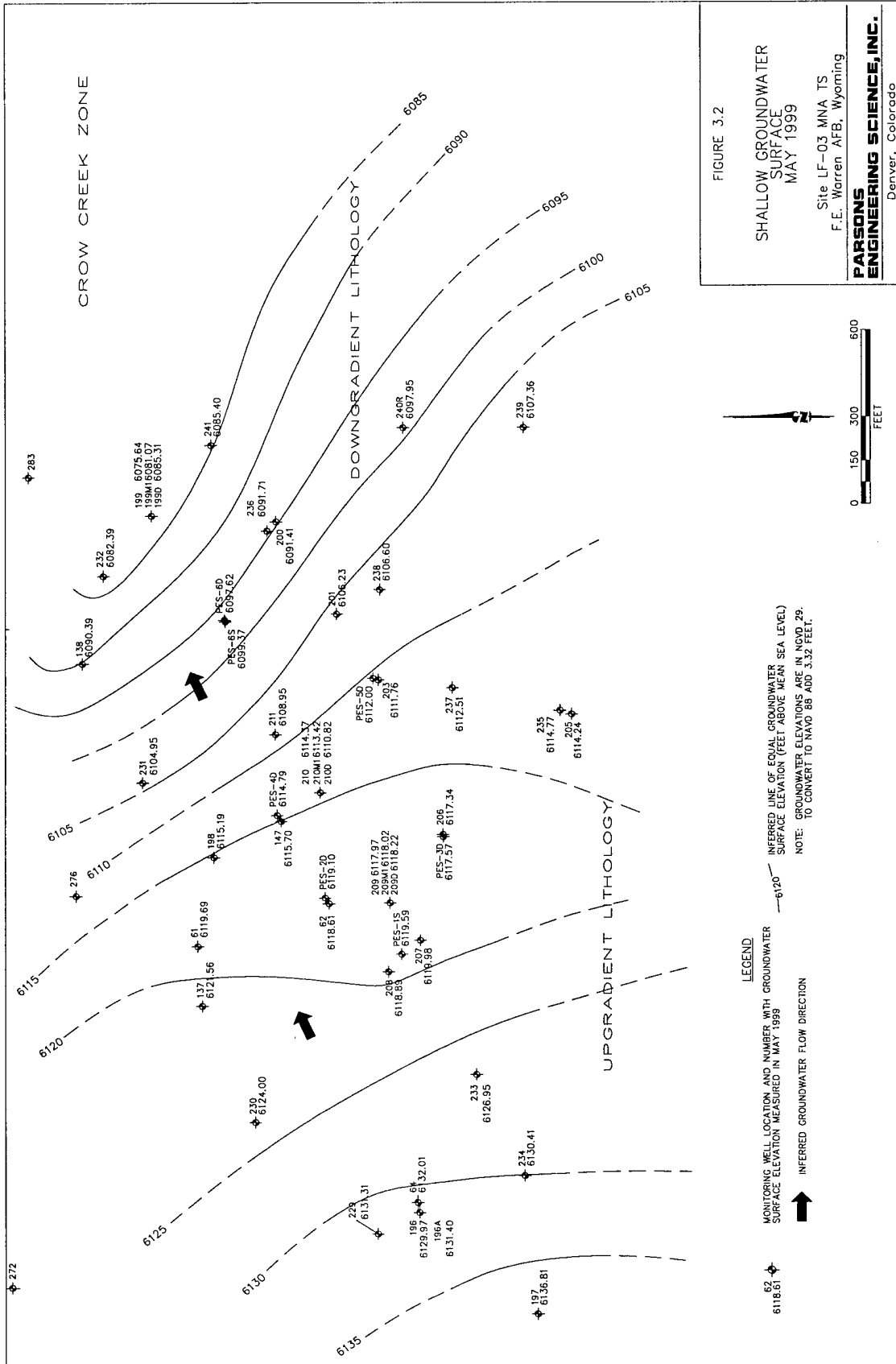


Figure 3.2 Shallow Groundwater Surface (after Parsons Engineering Science (1999))

<b>Variable</b>	<b>Value</b>
Estimated Effective Porosity	0.2
Bulk Density of Aquifer Solids	1.65 kg/l
Average Hydraulic Gradient	0.02 ft/ft
Average Hydraulic Conductivity	
Range	0.03 - 4.46 ft/day
Upgradient Lithology (see Figure 3.2)	4.0 ft/day
Downgradient Lithology (see Figure 3.2)	0.8 ft/day
Crow Creek Zone (see Figure 3.2)	2.0 ft/day
Average Groundwater Velocity	
Range	1.1 - 163 ft/yr
Geometric Average	6.9 ft/yr

**Table 3.3 Groundwater Flow Parameter Values**

adequately, this research will focus on the application of the contaminant transport model to the site.

### **3.3.2 Contaminant Fate and Transport Model**

This research will model the natural attenuation TCE, DCE, and VC due to reductive dehalogenation. This section will discuss how BR3D will be applied to the site, to include fate and transport processes modeled and initial and boundary conditions assumed.

#### **3.3.2.1 Processes Modeled**

BR3D can model 3D advection, 3D dispersion, equilibrium or rate-limited sorption, and several biodegradation processes. Assuming steady state groundwater flow, linear sorption, and constant porosity (both spatially and temporally), these processes can be incorporated into the general transport equation for a single contaminant (Charbeneau, 2000; Domenico and Schwartz, 1998):

$$R \frac{dC}{dt} = -\underline{v} \cdot \nabla C + \nabla \cdot (\underline{D} \cdot \nabla C) \pm r_{\text{bio}} \quad (3.1)$$

where

$C$  = concentration of contaminant in aqueous phase [M/L<sup>3</sup>]

$t$  = time [T]

$\underline{v}$  = average linear velocity vector (in the x,y, and z direction) [L/T]

$\underline{D}$  = dispersion coefficient matrix [L<sup>2</sup>/T]

$r_{\text{bio}}$  = source/sink term for contaminant production/destruction in aqueous phase  
[M/L<sup>3</sup>-T]

$R$  = retardation factor of contaminant due to sorption [-]

On the right hand side of the equation, the first term represents advection, the second dispersion, and the third biological reactions. Linear equilibrium sorption is included on the left side of the equation in the  $R$  term. The remainder of this section will describe the specific sorption and reaction equations used in BR3D to solve the general transport equation.

Retardation due to linear equilibrium sorption can be described using the equation

$$R = 1 + K_D \frac{\rho_b}{\theta} \quad (3.2)$$

where

$R$  = retardation factor of contaminant [-]

$K_D$  = distribution coefficient of contaminant (L<sup>3</sup>/M)

$\theta$  = porosity (-)

$\rho_b$  = bulk density of aquifer solids (M/L<sup>3</sup>)

The distribution coefficient of the contaminant,  $K_D$ , can be determined by (Domenico and Schwartz, 1998):

$$K_d = K_{OC}f_{OC} \quad (3.3)$$

where

$K_{OC}$  = partition coefficient of a contaminant between organic carbon and water (L<sup>3</sup>/M)

$f_{OC}$  = weight fraction of organic carbon in the aquifer solids (-)

As  $K_{OC}$  values were not experimentally determined at Site LF-03, they may be estimated using the relationship (Domenico and Schwartz, 1998)

$$\log K_{OC} = -0.21 + \log K_{OW} \quad (3.4)$$

where

$K_{OW}$  = partition coefficient of a contaminant between octanol and water (-)

BR3D also models the biodegradation processes at Site LF-03. Reductive dehalogenation of chlorinated ethenes is assumed to be the dominant process, and is described using first order kinetics:

$$r_{bio} = \frac{dC}{dt} = -kC \quad (3.5)$$

where

$C$  = concentration of dissolved contaminant (M/L<sup>3</sup>)



k = contaminant decay first order rate constant ( $T^{-1}$ )

### 3.3.2.2 Initial and Boundary Conditions

It is assumed that TCE started leaching into the groundwater in 1960, and that no contamination was present before that time. TCE is the only contaminant infiltrating into the groundwater; DCE and VC are assumed to be present from the reduction of aqueous phase TCE. It is also assumed that TCE infiltrates from cells in three designated source zones, as shown in Figure 3.3. The mass loading rate of TCE entering the aquifer is listed in Table 3.4.

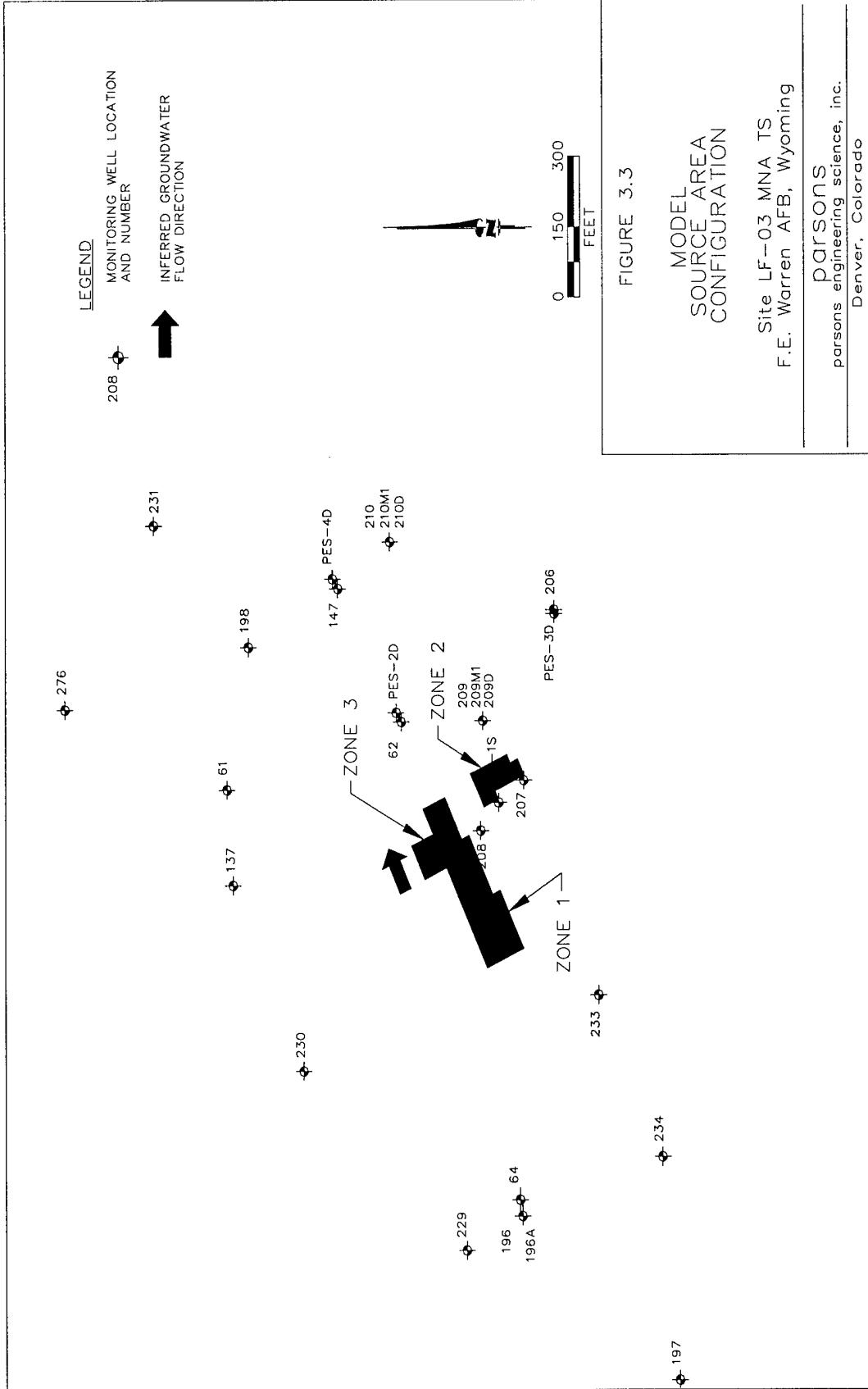
Time	Source Zone 1	Source Zone 2	Source Zone 3
1960-1965	0.0028	0	0
1965-1970	0.0028	0	0
1970-1975	0.0028	0	0
1975-1980	0.0019	0.0094	0
1980-1985	0.0013	0.0047	0.0094
1985-1990	0.0009	0.0024	0
1990-1995	0.0006	0.0094	0
1995-1999	0.0004	0.0047	0

**Table 3.4 TCE Mass Loading per Cell (in kg/yr) (after Parsons Engineering Science, 1999)**

## 3.4 Site Model Validation

In this research, model calibration will be performed using data collected in 1993, while a predictive simulation will be compared to observations made in 1999.

Both calibration and validation will include concentration contour plots and goodness-of-fit statistics in order to evaluate model performance.



**Figure 3.3 Model Source Area Configuration (after Parsons Engineering Science (1999))**

### 3.4.1 Calibration

BR3D will be calibrated using concentrations of TCE, DCE, and VC observed in 1993 (see Table 3.5) through the use of RMSE.

Site Well #	Corresponding Model Location						Observed Concentrations		
	Obs Pt	Row	Col	Layer	X	Y	TCE	cis-1,2DCE	VC
62	1	46	87	1	1736	1588	2.00E-05	1.22E-05	0.00E+00
147	2	45	104	1	2065	1611	1.50E-05	8.20E-06	0.00E+00
198	3	32	103	1	2045	1866	0.00E+00	0.00E+00	0.00E+00
199	4	48	161	1	3210	1553	1.20E-06	0.00E+00	0.00E+00
201	6	69	132	1	2639	1139	1.30E-06	0.00E+00	0.00E+00
203	7	70	119	1	2375	1108	8.80E-06	0.00E+00	0.00E+00
206	8	69	90	1	1797	1139	6.40E-06	1.00E-06	0.00E+00
207	9	57	75	1	1490	1365	1.10E-05	5.00E-06	0.00E+00
208	10	50	72	1	1436	1509	2.00E-05	1.60E-05	0.00E+00
209	11	55	83	1	1652	1402	3.40E-05	2.80E-05	0.00E+00
210	13	53	105	1	2100	1450	4.40E-05	2.40E-05	9.00E-07
211	15	51	118	1	2349	1500	1.90E-05	9.10E-06	9.00E-07
232	16	36	155	1	3088	1786	0.00E+00	0.00E+00	0.00E+00
233	17	56	50	1	989	1393	0.00E+00	0.00E+00	0.00E+00
236	18	64	150	1	2998	1227	0.00E+00	0.00E+00	0.00E+00

**Table 3.5 Observed Chlorinated Ethene Concentrations for 1993 (after Parsons Engineering Science (1999))**

By inspecting the values observed in 1993, it can be seen that chlorinated ethene concentrations are much larger at some observation points than at others. For example, the concentration of TCE at Observation Point 13 is over 35 times greater than TCE concentration at Observation Point 4. If we fit the raw data, these large values will exert an undue influence on the calibration by masking the contribution of other observation points to the overall model fit. In order to dampen the effect of these extreme values on the goodness-of-fit statistics, it was decided to perform a log transformation on the concentration values. As the data values themselves are of interest (as opposed to the difference in values

being important) and due to the large range of the values, logs of base 10 will be used (Cole, 2000). The transformed data will then be analyzed using RMSE.

The parameters to be varied in the calibration are listed in Table 3.6, while parameters held constant are listed in Table 3.7.

Parameter	Symbol	Range of Values	Source
First order rate constant for TCE	$K_{TCE}$	0 – 0.023 d <sup>-1</sup>	Suarez and Rifai, 1999
First order rate constant for DCE	$k_{DCE}$	0 - 0.130 d <sup>-1</sup>	Suarez and Rifai, 1999
First order rate constant for VC	$k_{VC}$	0 - 0.007 d <sup>-1</sup>	Suarez and Rifai, 1999

**Table 3.6 Model Parameters Varied During Calibration**

Parameter	Symbol	Value	Source
Longitudinal Dispersivity	$\alpha_L$	25 ft	Parsons Engineering Science, 1999
Transverse Dispersivity	$\alpha_T$	2.5 ft	Parsons Engineering Science, 1999
Vertical Dispersivity	$\alpha_V$	0.9 ft	Parsons Engineering Science, 1999
Retardation factor for TCE	$R_{TCE}$	1.33	CRC Press, 1997; Equations 3.2 – 3.4
Retardation factor for DCE	$R_{DCE}$	1.28	CRC Press, 1997; Equations 3.2 – 3.4
Retardation factor for VC	$R_{VC}$	1.22	CRC Press, 1997; Equations 3.2 – 3.4

**Table 3.7 Model Parameters Held Constant During Calibration**

The first order decay rate constants for TCE, DCE, and VC will be varied to minimize the RMSE of all three contaminants. Observed and calibrated contaminant contour plots and optimized RMSE, bias(B) and coefficient of efficiency (E) will be reported for each contaminant as a measure of model calibration.

### **3.4.2 Quantitative Comparative Analysis**

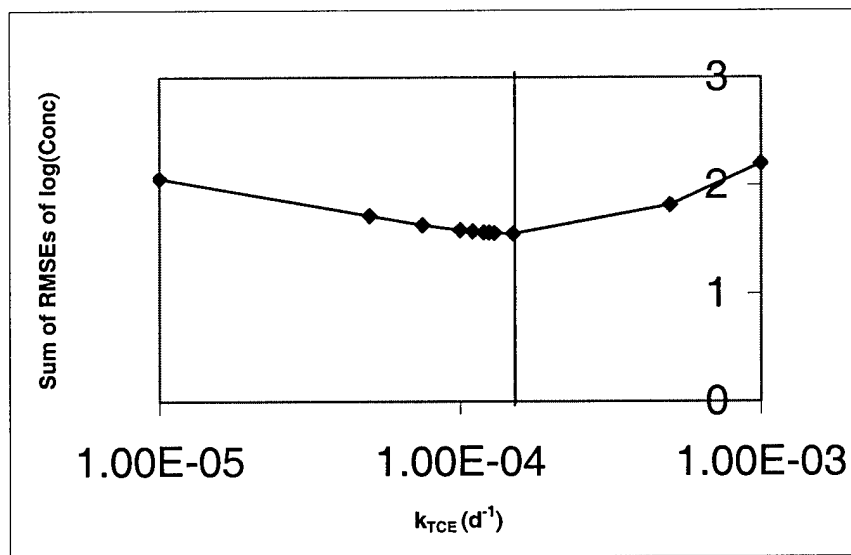
After BR3D is calibrated to 1993 data, a predictive simulation will be performed.

The model will be run from 1960 to 1999, and results will be compared to the 1999 observed concentrations of TCE, DCE, and VC. As with the model calibration, observed and calibrated contaminant contour plots and RMSE, bias (B) and coefficient of efficiency (E) will be reported for each contaminant.

## 4.0 Analysis

### 4.1 Calibration Results

Chlorinated ethene decay rate constants were estimated using a forward, trial-and-error process. Using the sum of the three chlorinated ethene RMSEs as the objective function, the decay rates for DCE and VC were held constant while the decay rate for TCE was varied to minimize the RMSE sum (see Figure 4.1).



**Figure 4.1 Calibration of TCE First Order Decay Constant for  $k_{DCE}=1 \times 10^{-5} d^{-1}$ ,  $k_{VC} = 1 \times 10^{-6} d^{-1}$**

Once a  $k_{TCE}$  was found that minimized the objective function (sum of RMSE),  $k_{DCE}$  was varied while  $k_{TCE}$  and  $k_{VC}$  were held constant. This process was repeated until  $k_{TCE}$ ,  $k_{DCE}$ , and  $k_{VC}$  each converged to a value that produced the (hopefully) global minimum objective function. The calibrated decay rates are listed in Table 4.1.

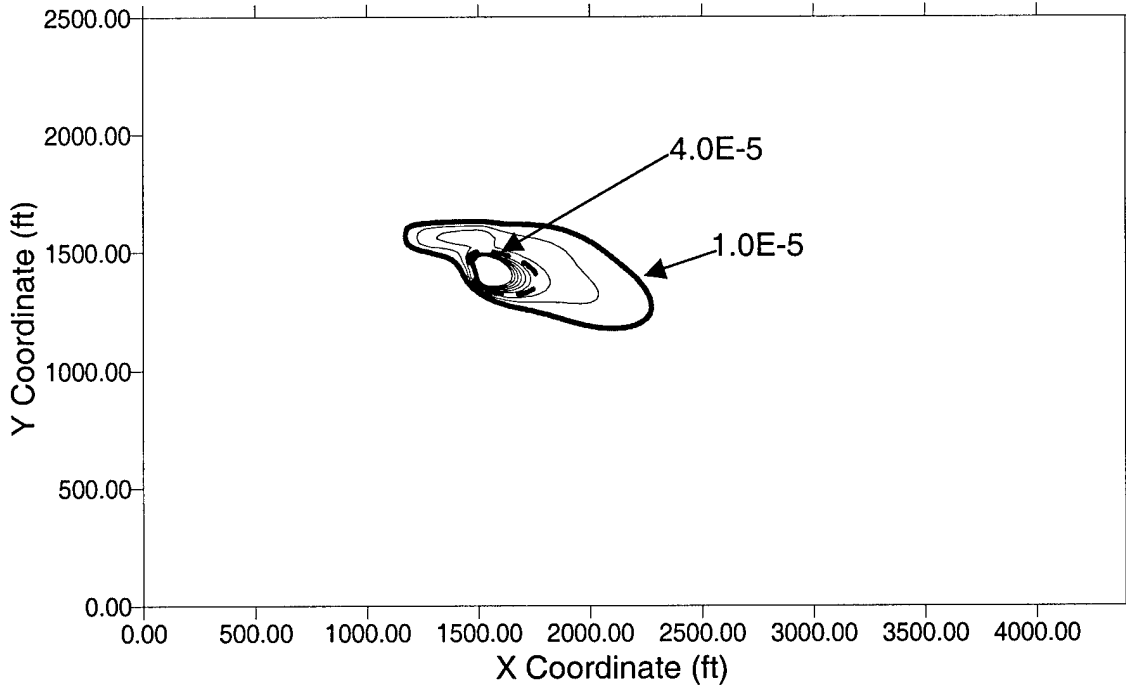
	First Order Rate Constant, k (d-1)
TCE	2.3x10-4
DCE	1.8x10-4
VC	0

**Table 4.1 Calibrated Model Parameters**

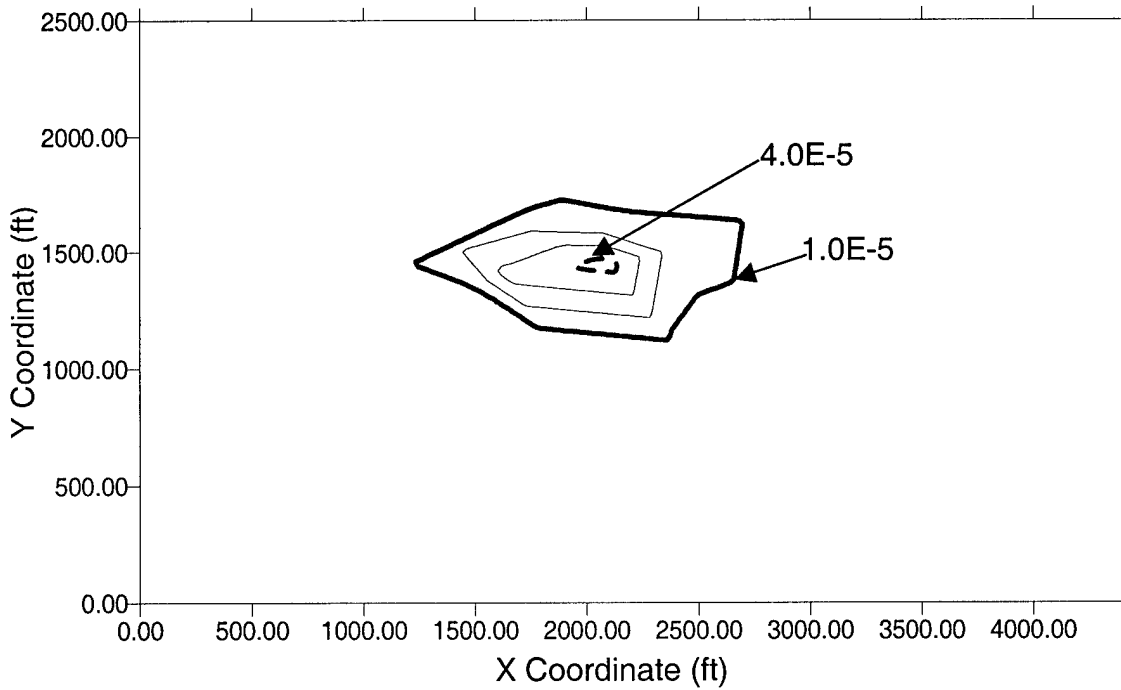
The fit values for first order decay are reasonable, in that they fall within the range of values reported in the literature (Suarez and Rifai, 1999). It can also be seen that the greater number of chlorine substituents a contaminant has, the greater the rate of decay ( $k_{TCE} > k_{DCE} > k_{VC}$ ). These two facts support the assumption that the aquifer is anaerobic, and that reductive dehalogenation is an important process at the site.

Significant insight can be gained through qualitative evaluation of the calibrated fit. To this end, simulated and observed concentration contour plots for TCE (Figures 4.2 and 4.3, respectively), DCE (Figures 4.4 and 4.5), and VC (Figures 4.6 and 4.7) were generated using the linear interpolation option of Surfer (Version 5.03), a surface mapping program.

In comparing the concentration contour plots, we found that simulated concentrations matched observed concentrations reasonably well for TCE and VC, while the DCE concentration data were less well matched. Specifically, it is apparent that the calibrated model slightly underestimates the observed concentration of DCE found at Site LF-03.

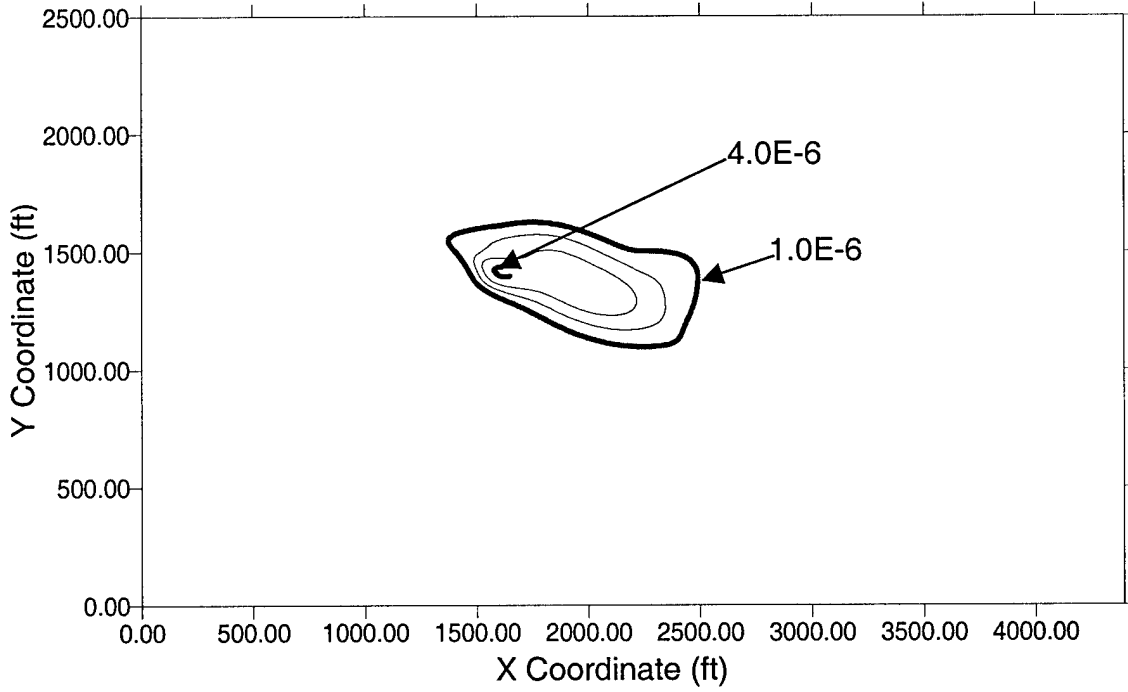


**Figure 4.2 Calibrated TCE Concentration Contour Plot, Layer 1 (g/L)**

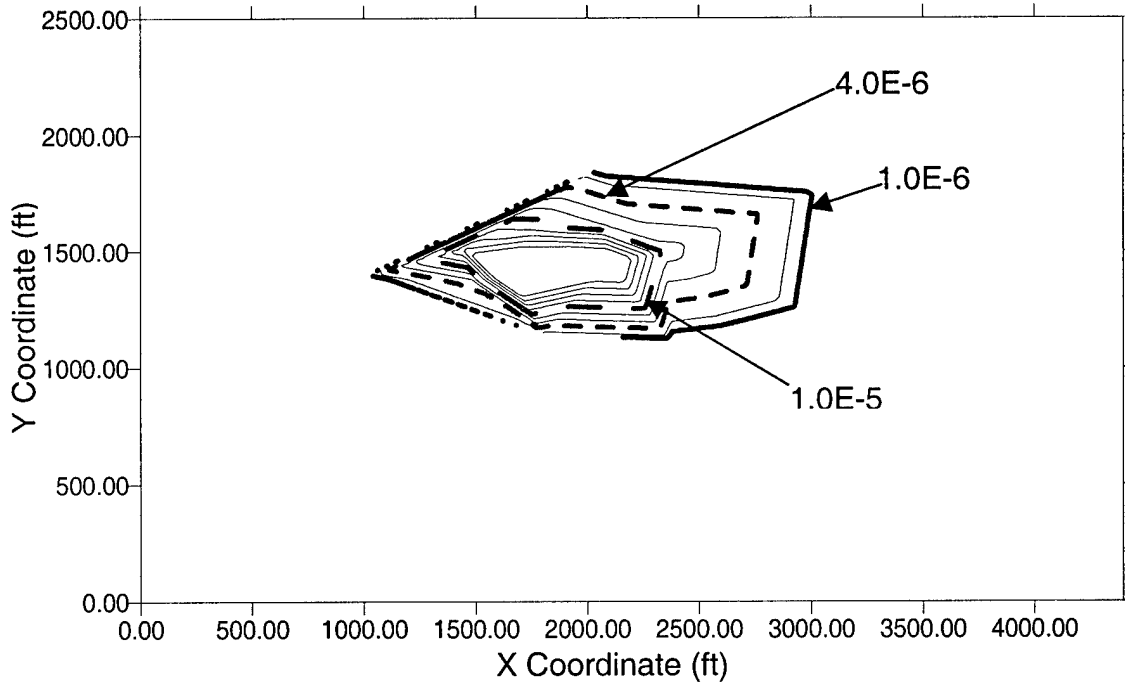


**Figure 4.3 1993 Observed TCE Concentration Contour Plot, Layer 1 (g/L)**

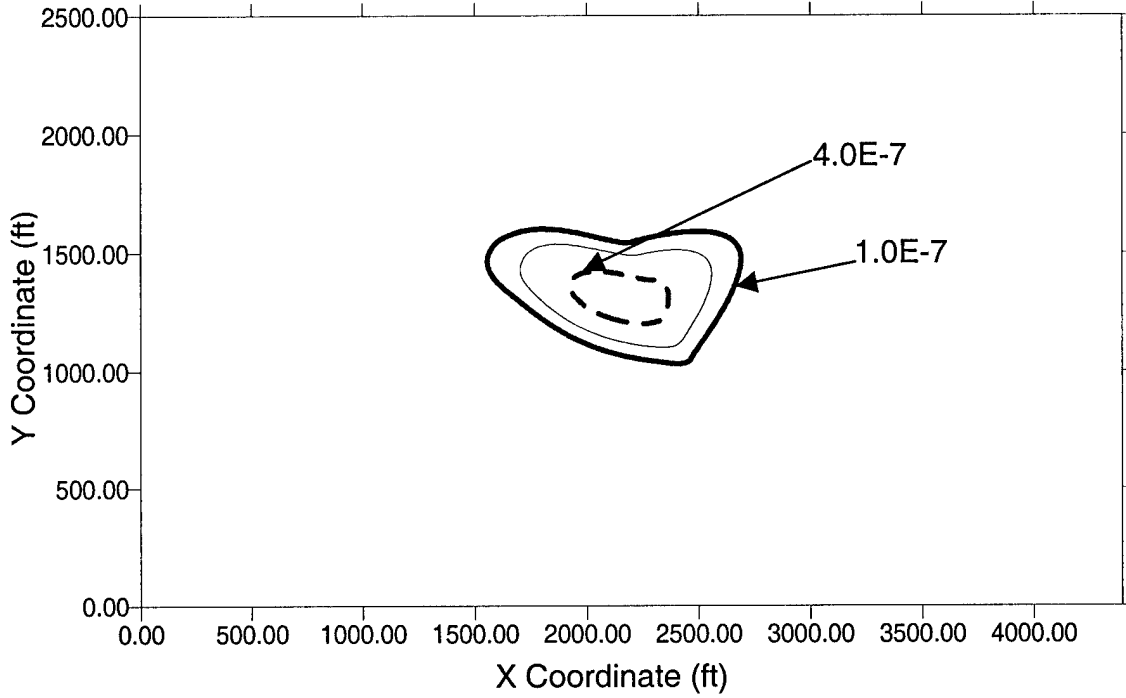




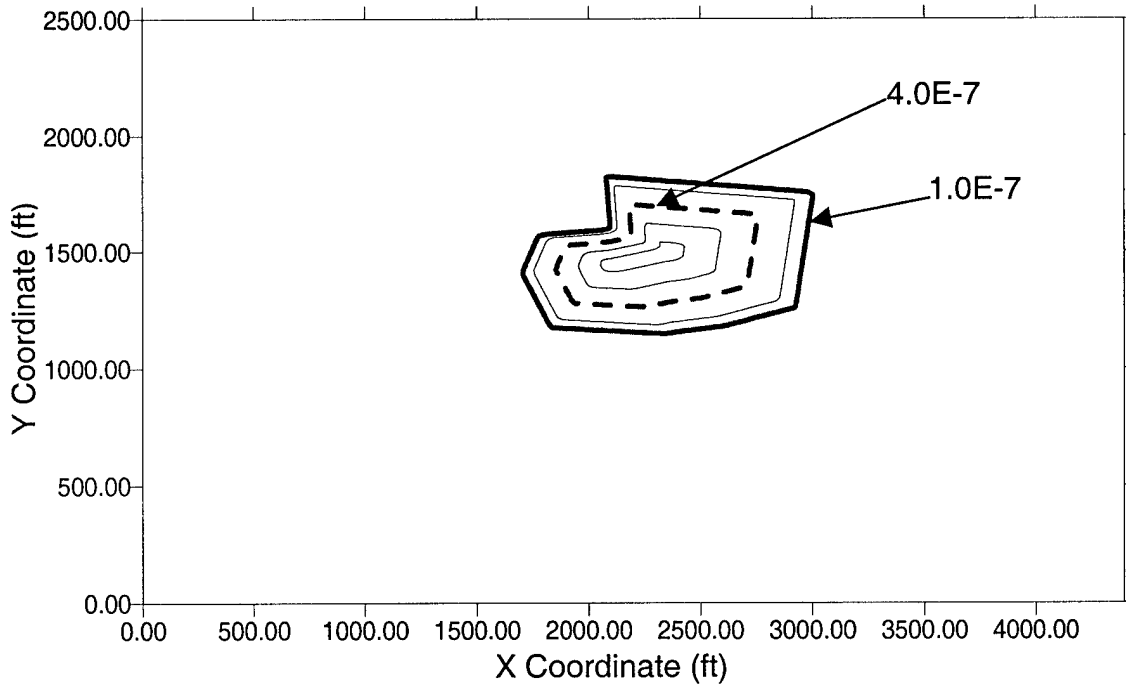
**Figure 4.4 Calibrated DCE Concentration Contour Plot, Layer 1 (g/L)**



**Figure 4.5 1993 Observed DCE Concentration Contour Plot, Layer 1 (g/L)**



**Figure 4.6 Calibrated VC Concentration Contour Plot, Layer 1 (g/L)**



**Figure 4.7 1993 Observed VC Concentration Contour Plot, Layer 1 (g/L)**

Goodness-of-fit statistics were also used to evaluate the calibrated fit. Table 4.2 contains statistics that describe the absolute magnitude of errors (RMSE), relative magnitude of errors (E), and direction and magnitude of the model's tendency for over- or under-prediction (B, B<sup>2</sup>) for each chlorinated ethene.

	RMSE (log(ppm))	E (-)	B (log(ppm))	B <sup>2</sup> (-)
TCE	0.55	0.71	-0.27	0.069
DCE	0.74	0.51	-0.42	0.16
VC	0.21	0.60	-0.030	0.008

**Table 4.2 Goodness-of-Fit Statistics for Model Calibration**

The model bias (B) of each contaminant reveals that concentrations for all three are being under-estimated, with DCE having the greatest magnitude of bias (B<sup>2</sup>). This under-estimation could have significant implications if the model is to be used to predict chlorinated ethene fate and transport. However, the coefficient of efficiency for the three contaminants (E), while less than the ideal value of 1, is greater than zero. Using E as a gauge of model performance is relatively new to contaminant transport modeling. Accordingly, there is no consensus of what value of E indicates an acceptable fate and transport model, especially when the data have been log transformed. However, as this model did not require a major calibration (only three parameters varied), it may be possible to follow the example given by Frankenberger et al. (1999) for the validation of a hydrology model. If this example is applicable, values in the range of E = 0.60 can be considered good, as is the case for TCE and DCE fit. Values of E ≤ 0.5, as in the case for VC fit, tend to indicate poor model performance. However, it should be

noted that the VC fit was based on only two quantifiable data points (wells 210 and 211 in Table 3.5), and that the  $k_{VC}$  is essentially zero. This essentially means that only two fitting parameters ( $k_{TCE}$  and  $k_{DCE}$ ) were used to calibrate the model to TCE and DCE data. This fact was taken into consideration along with the evaluation of concentration contour plots and the goodness-of-fit statistics. After a review of the information, we concluded that the calibrated model provided a good fit to the TCE and DCE data, and an acceptable fit to the VC data. The fact that the model can be reasonably calibrated with minimal fitting parameters suggests that the modeling assumptions of linear equilibrium sorption and first order decay are not invalid.

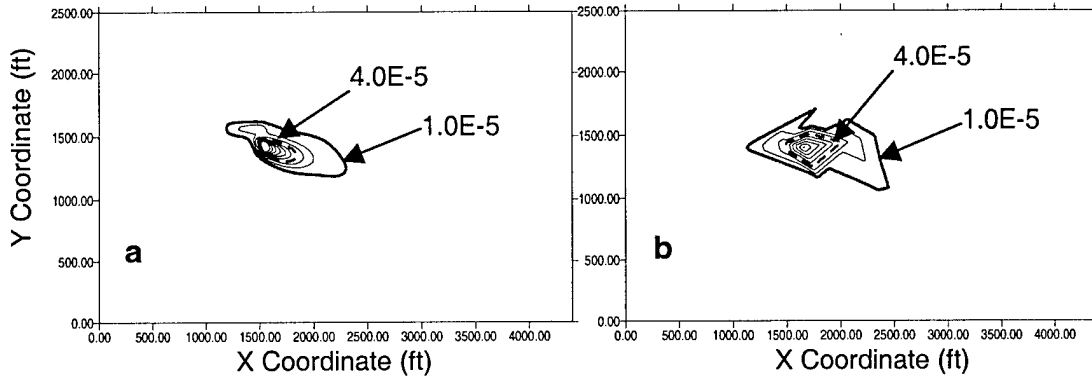
## **4.2 Predictive Simulation and Comparative Analysis**

After the decay rate constants were calibrated, a predictive simulation was run from 1960 to 1999. Simulation values were then compared to values observed at Site LF-03 in 1999 (Table 4.3). Figures 4.8, 4.9, and 4.10 show the simulated and observed chlorinated ethene concentrations.

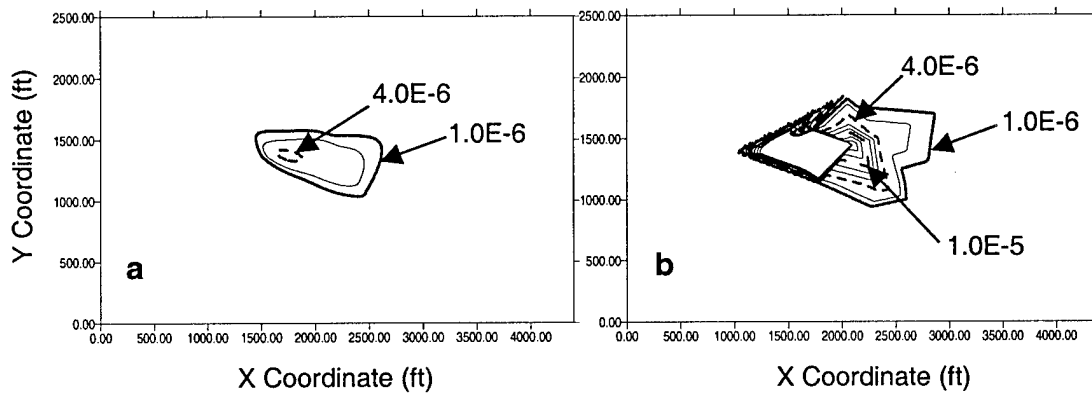
Inspection of the  $4 \times 10^{-5}$  contour lines in Figure 4.8 indicates that simulated TCE concentration matches well to observed data, while an inspection of Figure 4.9 shows that DCE is considerably underestimated in the simulation. In contrast, the model overestimates VC concentrations (see Figure 4.10). It should be noted, however, that the simulated VC concentration are nearly equal to the VC detectable limit of  $1 \times 10^{-7}$  g/L, such that the overestimation is relatively small.

Site Well #	Corresponding Model Location						Observed Concentrations (g/L)		
	Obs Pt	Row	Col	Layer	X	Y	TCE	Cis-1,2DCE	VC
62	1	46	87	1	1736	1588	5.00E-07	5.00E-07	0.00E+00
147	2	45	104	1	2065	1611	1.04E-05	5.90E-06	0.00E+00
198	3	32	103	1	2045	1866	0.00E+00	0.00E+00	0.00E+00
199	4	48	161	1	3210	1553	0.00E+00	0.00E+00	0.00E+00
199M1	5	48	161	3	3210	1553	0.00E+00	0.00E+00	0.00E+00
201	6	69	132	1	2639	1139	5.00E-07	0.00E+00	0.00E+00
203	7	70	119	1	2375	1108	1.28E-05	5.10E-06	0.00E+00
206	8	69	90	1	1797	1139	2.60E-06	1.20E-06	0.00E+00
207	9	57	75	1	1490	1365	3.31E-05	3.66E-05	0.00E+00
208	10	50	72	1	1436	1509	2.30E-05	2.28E-05	0.00E+00
209	11	55	83	1	1652	1402	9.31E-05	1.29E-04	0.00E+00
209M1	12	55	83	2	1652	1402	7.71E-05	5.11E-05	0.00E+00
210	13	53	105	1	2100	1450	2.67E-05	1.59E-05	0.00E+00
210M1	14	53	105	3	2100	1450	1.83E-05	6.90E-06	0.00E+00
211	15	51	118	1	2349	1500	7.50E-06	3.30E-06	0.00E+00
232	16	36	155	1	3088	1786	0.00E+00	0.00E+00	0.00E+00
233	17	56	50	1	989	1393	5.00E-07	0.00E+00	0.00E+00
236	18	64	150	1	2998	1227	5.00E-07	0.00E+00	0.00E+00
237	19	81	113	1	2246	895	0.00E+00	0.00E+00	0.00E+00
238	20	77	133	1	2655	971	1.12E-06	0.00E+00	0.00E+00
PES-1S	21	53	74	1	1473	1442	3.39E-05	3.35E-05	0.00E+00
PES-2D	22	46	88	3	1759	1591	4.30E-06	2.30E-06	0.00E+00
PES-3D	23	68	90	3	1786	1143	5.00E-07	0.00E+00	0.00E+00
PES-4D	24	45	105	3	2090	1615	1.23E-05	3.00E-06	0.00E+00
PES-5D	25	69	120	3	2387	1122	3.30E-06	1.30E-06	0.00E+00
PES-6S	26	51	139	2	2782	1485	1.10E-05	2.50E-06	0.00E+00
PES-6D	27	51	140	3	2771	1485	0.00E+00	0.00E+00	0.00E+00

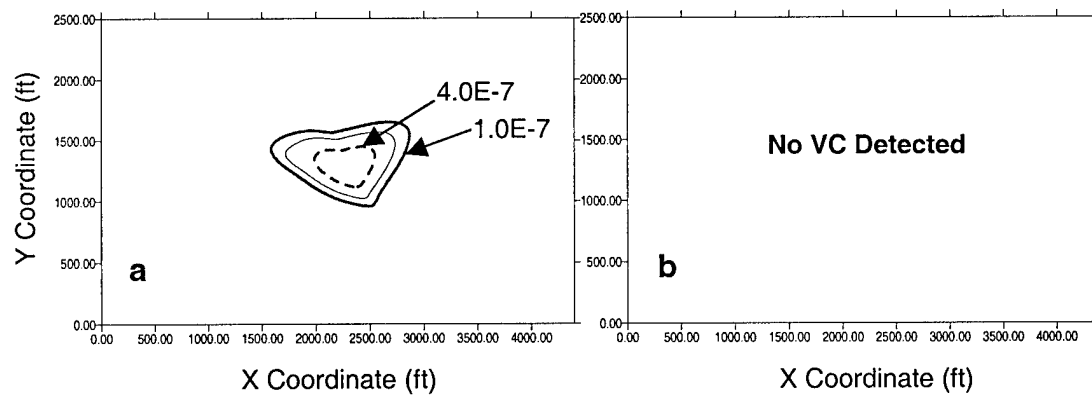
**Table 4.3 Observed Chlorinated Ethene Concentrations for 1999 (after Parsons Engineering Science (1999))**



**Figure 4.8 Simulated (a) and Observed(b) TCE Concentrations for 1999**



**Figure 4.9 Simulated (a) and Observed (b) DCE Concentrations for 1999**



**Figure 4.10 Simulated (a) and Observed (b) VC Concentrations for 1999**

To complete the evaluation of model performance, goodness-of-fit statistics for the predictive simulation (summarized in Table 4.4) were calculated.

	RMSE (log(ppm))	E (-)	B (log(ppm))	B' <sup>2</sup> (-)
TCE	0.50	0.77	-0.09	0.009
DCE	0.77	0.47	-0.39	0.14
VC	0.24	-	0.13	-

**Table 4.4 Goodness-of-Fit Statistics for 1999 Data**

As VC was not observed at Site LF-03 in 1999, the observed variance of VC concentrations equals zero. This prevents the calculation of the Nash-Sutcliffe coefficient of efficiency (E) and the non-dimensional bias (B'<sup>2</sup>) for this data set. Regardless, interesting observations can be made from the statistics. First, the magnitude of non-dimensional bias (B'<sup>2</sup>) for TCE decreased from 0.069 in 1993 to 0.009 in 1999. It is hypothesized that the TCE loading rate in the first few time steps (see Table 3.4) may have been insufficient, resulting in the underestimation of TCE concentration later in the simulation. This reduction in the magnitude of bias has implications for another goodness-of-fit statistic, as E is related to B'<sup>2</sup> by equation 2.18:

$$E = R^2 - C^2 - B'^2 \quad (2.18)$$

The decrease in B'<sup>2</sup> could account for the unusual circumstance that the model fits the observed data better when in the predictive mode than when the fit was calibrated, as shown by the increase in E from 0.71 to 0.77. The value of E for TCE suggests that the TCE concentration fit is good (Frankenberger et al., 1999). Second, the value of E for DCE is relatively low (below 0.50), indicating that the fit of simulated DCE to the observed values is relatively poor

(Frankenberger et al., 1999). Lastly, the positive value of VC bias (B) indicates that VC is being over-predicted. As no VC was observed at Site LF-03 in 1999, any model prediction over  $1 \times 10^{-7}$  g/L (the detection limit for VC) would result in over-prediction.

While chlorinated ethene advection is relatively slow, and only six additional years have been simulated, we found that BR3D provided good predictions of TCE concentrations and fair predictions of DCE concentration, while lack of quantifiable data precludes the evaluation of VC prediction. From these observations of model performance, we inferred that the assumptions of linear equilibrium sorption and reductive dehalogenation were not invalid when describing TCE and DCE fate and transport.



## 5.0 Conclusion

### 5.1 Summary

In this thesis, the contaminant fate and transport model BR3D was applied to Site LF-03 on F.E. Warren Air Force Base to simulate the natural attenuation of TCE, DCE, and VC through reductive dehalogenation. Reductive dehalogenation was modeled as a first order process, with decay rate constants being calibrated through a forward, trial-and-error process. After model calibration, a predictive simulation was performed. Simulated values for chlorinated ethene concentrations were compared to observed values using concentration contour plots and goodness-of-fit statistics.

### 5.2 Calibration

The calibrated values for first order decay were found to be reasonable, in that they fell within the range of values reported in the literature (Suarez and Rifai, 1999). Contaminants with greater number of chlorine substituents had greater rates of decay ( $k_{TCE} > k_{DCE} > k_{VC}$ ), as would be expected in an anaerobic aquifer where reductive dehalogenation is taking place. After a simulation was run using the fit decay rates, a comparison of the concentration contour plots revealed that simulated concentrations matched observed concentrations reasonably well for TCE and VC, while the simulated DCE concentration tended to underestimate the observed data. It should be noted that choosing other decay rates could

have improved DCE fit, but this would have resulted in the degeneration of TCE and VC fit such that the overall fit of the model would have suffered.

The model bias for each contaminant revealed that TCE, DCE, and VC were being under-estimated, with DCE having the greatest magnitude of bias.

However, the coefficient of efficiency for the three contaminants (E), showed that the model performed better than the mean value at estimating chlorinated ethene concentrations. Specifically, values of E were judged as good for TCE and DCE but poor for VC. As BR3D is minimally calibrated (essentially only two fitting parameters) we concluded that the calibrated model provided a good fit to the TCE and DCE data, and an acceptable fit to the VC data. The fact that the model can be reasonably calibrated with minimal fitting parameters suggests that the modeling assumptions of linear equilibrium sorption and first order decay are not invalid.

### **5.3 Predictive Simulation and Comparative Analysis**

After BR3D was calibrated, a predictive simulation was run, with results compared to observations made in 1999. Inspection of simulated and observed contour plots revealed that simulated TCE concentrations matched well to observed data, while simulated DCE concentrations were underestimated and simulated VC concentrations overestimated. The value of E for TCE (0.77) suggests that the TCE concentration fit is good, while the value of E for DCE (0.47) indicated that fit of simulated DCE to observed values was relatively poor

(Frankenberger et al., 1999). While E could not be calculated for VC, the positive value of VC bias (B) indicated that VC was being over-estimated.

While chlorinated ethene advection is relatively slow, and only six additional years were simulated, we found that BR3D provided good predictions of TCE concentrations and fair predictions of DCE concentrations. Due to a lack of quantifiable data, no conclusions were drawn regarding VC predictions. From these conclusions regarding model performance, we made the inference that TCE and DCE fate and transport could be simulated by an advection/dispersion model that assumes linear equilibrium sorption and first order decay.

#### **5.4 Areas for Further Research**

1. In Chapter 3, sorption was assumed to be a linear equilibrium process. To test this assumption, the Damköhler number was calculated for the site. The Damköhler number I ( $Da_1$ ), defined as the ratio between advection and reaction time scales, can be used to indicate if sorption is rate-limited or in equilibrium. If the  $Da_1$  is large, then advection is slow in comparison to sorption, suggesting that sorption can be modeled as an equilibrium process. Conversely, a small  $Da_1$  indicates advection is fast compared to sorption, and that sorption would be best modeled as a rate-limited process. The value of  $Da_1$  depends on the groundwater velocity, length scale (typically, diameter of the porous material), and the sorption rate constant. Using site values for average groundwater velocity and

literature values for the diameter of sand (the predominant aquifer material found during the treatability study) and a sorption rate constant, we calculated  $Da_1 = 1.4 \times 10^{-3}$ . Since  $Da_1 \ll 1$ , sorption at the site may best be modeled as a rate-limited process instead of an equilibrium process.

2. While it is hypothesized that DCE and VC are aerobically oxidized downgradient of the source, the lack of oxygen data for the site precludes modeling this process. Validation of a site with more comprehensive geochemical data might instill more confidence in the model's ability to simulate complex biological processes.
3. The calibration of the contaminant transport model was accomplished through a trial-and-error, forward process. While this method was adequate for the purposes of this research, it may be possible to obtain a better fit to the observed concentrations using a nonlinear simulation-regression code, such as UCODE (Hill, 1998; Gandhi et al., in review), to estimate model parameters.
4. This research modeled the natural attenuation of chlorinated ethenes by reductive dehalogenation. As additional models are developed to describe the processes thought to be taking place at Site LF-03, the methodology developed in this thesis can be used to measure the predictive ability of each new model. The resulting best-fit statistics can

then be compared. Hill (1998) provides an introduction to model comparison, and specifically discusses comparison between models with different numbers of input parameters, while Legates and McCabe (1999) discuss the necessary methods to determine the statistical significance of the coefficient of efficiency.

5. RMSE and E are overly sensitive to extreme values due to the squared differences used in their calculation. Legates and McCabe (1999) discuss the use of nonparametric or rank correlation methods, as well as goodness-of-fit statistics that rely on the absolute error rather than the squared error. Such methods could prove useful in further model validation efforts.

## 6.0 Bibliography

- Ababou, R., B. Sagar, and G. Wittmeyer. Testing procedures for spatially distributed flow models, Advances in Water Resources, 15: 181-198, 1992
- Adamson, D.T. and G.F. Parkin. Impact of mixtures of chlorinated aliphatic hydrocarbons on high-rate, tetrachloroethene-dechlorinating enrichment culture, Environmental Science and Technology, 34(10):1959-1965, 2000
- Agency for Toxic Substances and Disease Registry (ATSDR). 1996. National Exposure Registry: Trichloroethylene (TCE) Subregistry Followup 1 Report., U.S. Public Health Service, Department of Health and Human Services, Atlanta, GA, 1996  
<http://www.atsdr.cdc.gov/NER/tech.html>
- American Society for Testing and Materials (ASTM). Standard Guide for Developing and Evaluating Ground-Water Modeling Codes. D6025—96<sup>e</sup>. West Conshohocken, PA, 1996
- American Society for Testing and Materials (ASTM). Standard Guide for Selecting a Ground-Water Modeling Code. D6170-97<sup>e1</sup>. West Conshohocken, PA, 1997
- Anderson, J.E. and P.L. McCarty. Transformation yields of chlorinated ethenes by a methanotrophic mixed culture expressing particulate methane monooxygenase, Applied Environmental Microbiology, 63: 687-693, 1997
- Armstrong, A.C., A.M. Portwood, P.B. Leeds-Harrison, G.L. Harris, and J.A. Catt. The Validation of Pesticide Leaching Models, Pesticide Science, 48: 47-55, 1996
- Arnold, J.G., J.R. Williams, R. Srinivasan, and K.W. King. Soil and Water Assessment Tool User Manual. Texas A&M Blackland Research Center, Temple, TX, 1997  
<http://www.brc.tamus.edu/swat/usermanual/modelvalidation.html>
- Azadpour-Keeley, A., H.H. Russell, and G.W. Sewell. Microbial Processes Affecting Monitored Natural Attenuation of Contaminants in the Subsurface, EPA/540/S-99/001, USEPA, Ada, OK, 1999  
<http://www.epa.gov/ada/download/issue/microbial.pdf>
- Aziz, C.E., C.J. Newell, J.R. Gonzales, P. Haas, T.P. Clement, and Y. Sun. BIOCHLOR: Natural Attenuation Decision Support System User's Manual Version 1.0. EPA/600/R-00/008, USEPA, Washington, D.C., 2000

- Bair, E.S. Model (In)Validation – A View from the Courtroom, Ground Water, 32(4): 530-531, 1994
- Barton, A., M. Kelley, and A. Fisher. Modeling Chloroethene Behavior in Groundwater in Support of Natural Attenuation. In: Natural Attenuation Considerations and Case Studies: Remediation of Chlorinated and Recalcitrant Compounds. G.B. Wickramanayake, A.R. Gavaskar, and M.E. Kelley, eds. Battelle Press, Columbus, pp. 89-96, 2000
- Bloom, Y., R. Aravena, D. Hunkeler, E. Edwards, and S.K. Frape. Carbon Isotope Fractionation during Microbial Dechlorination of Trichloroethene, cis-1,2-Dichloroethene, and Vinyl Chloride: Implications for Assessment of Natural Attenuation, Environmental Science and Technology, 34(13):2768-2772, 2000
- Bradley, P.M. Microbial degradation of chloroethenes in groundwater systems, Hydrogeology Journal, 8: 104-111, 2000
- Bradley, P.M. and F.H. Chapelle. Effect of contaminant concentration on aerobic microbial mineralization of DCE and VC in stream-bed sediments, Environmental Science and Technology, 32(5): 553-557, 1998a
- Bradley, P.M. and F.H. Chapelle. Microbial mineralization of VC and DCE under different terminal electron accepting conditions, Anaerobe, 4: 81-87, 1998b
- Bradley, P.M., J.E. Landmeyer, and R.S. Dinicola. Anaerobic oxidation of [1-<sup>14</sup>C] dichloroethene under Mn(IV)-reducing conditions, Applied Environmental Microbiology, 64: 1560-1562, 1998
- Bredehoeft, J.D. and L.F. Konikow. Ground-water Models: Validate or Invalidate, Ground Water, 31(2): 178-179, 1993
- Bobba, A.G. Field Validation of 'SUTRA' Groundwater Flow Model to Lambton County, Ontario, Canada, Water Resources Management, 7: 289-310, 1993
- Bond, W.J, C.J. Smith, and P.J. Ross. Field validation of a water and solute transport model. In: International Association of Hydrogeologists: Shallow groundwater systems, International Association of Hydrogeologists, Rotterdam, 1998
- Bouwer, E.J. and P.L. McCarty. Utilization rates of trace halogenated organic compounds in acetate-supported biofilms, Biotechnology and Bioengineering, 27: 1564-1571, 1985

- Carey, G.R., P.J. Van Geel, J.R. Murphy, E.A. McBean, and F.A. Rovers. Modeling Natural Attenuation at the Plattsburgh Air Force Base. In: Natural Attenuation of Chlorinated Solvents, Petroleum Hydrocarbons, and Other Organic Compounds. B.C. Alleman and A. Leeson, eds. Battelle Press, Columbus, pp. 77-82, 1999
- Charbeneau, R.J. Groundwater Hydraulics and Pollutant Transport. Prentice-Hall, New Jersey, 2000
- Code of Federal Regulations (CFR). 40CFR141.50: Maximum contaminant level goals for organic contaminants. GPO, Washington, D.C., 2000  
[http://www.access.gpo.gov/nara/cfr/waisidx\\_00/40cfr141\\_00.html](http://www.access.gpo.gov/nara/cfr/waisidx_00/40cfr141_00.html)
- Code of Federal Regulations (CFR). 40CFR141.61: Maximum contaminant levels for organic contaminants. GPO, Washington, D.C., 2000  
[http://www.access.gpo.gov/nara/cfr/waisidx\\_00/40cfr141\\_00.html](http://www.access.gpo.gov/nara/cfr/waisidx_00/40cfr141_00.html)
- Cole, T.J. Sympercents: symmetric percentage differences on the 100 log<sub>e</sub> scale simplify the presentation of log transformed data, Statistics in Medicine, 19: 3109-3125, 2000
- Clark, M.M. Transport Modeling for Environmental Engineers and Scientists. Wiley & Sons, New York, 1996
- Clement, T.P., C.D. Johnson, Y. Sun, G.M. Klecka, C. Bartlett. Natural attenuation of chlorinated ethene compounds: model development and field-scale application at the Dover site, Journal of Contaminant Hydrology, 42: 113-140, 2000
- CRC Press. Handbook of Physical Properties of Organic Chemicals. P.H. Howard and W.M. Meylan, eds. Lewis Publishers, Boca Raton, FL, 1997
- Devore, J.L. Probability and Statistics for Engineering and the Sciences. 4<sup>th</sup> ed. Duxbury Press, Pacific Grove, CA, 1995
- Dolan, M.E., and P.L. McCarty. Small-column microcosm for assessing methane-stimulated vinyl chloride transformation in aquifer samples, Environmental Science and Technology, 29: 1892-1897, 1995
- Dominico, P.A. and F.W. Schwartz. Physical and Chemical Hydrogeology. 2<sup>nd</sup> Ed. Wiley & Sons, New York, 1998
- Eggleston, J.R., and S.A. Rojstaczer. Can We Predict Subsurface Mass Transport?, Environmental Science and Technology, 34(10): 4010-4017, 2000



- Frankenberger, J.R., E.S. Brooks, M.T. Walter, M.F. Walter, and T.S. Steenhuis. A GIS-based variable source area hydrology model, Hydrological Processes, 13: 805-822, 1999
- Feng, P.P. Modeling the Effect of Nonlinear and Rate-Limited Sorption on the Natural Attenuation of Chlorinated Ethenes. MS thesis, AFIT/GEE/ENV/00M-04. School of Engineering and Management, Air Force Institute of Technology (AU), Wright-Patterson AFB OH, March 2000
- Fetter, C.W. Contaminant Hydrogeology. Macmillan, New York, 1993
- Fox, D.G. Judging air quality model performance: A summary of the AMS workshop on dispersion model performance, Bulletin of the American Meteorological Society, 62: 599-609, 1981
- Freyberg, D.L. An Exercise in Ground-Water Model Calibration and Prediction, Ground Water, 26(2): 350-360, 1988
- Gandhi, R.K., G.D. Hopkins, M.N. Goltz, S.M. Gorelick, and P.L. McCarty. Full-scale demonstration of *in situ* cometabolic biodegradation of trichloroethylene in groundwater, 2: Comprehensive analysis of field data using reactive transport modeling, Water Resources Research, in review
- Garrick, M., C. Cunnane, and J.E. Nash. A criterion of efficiency for rainfall-runoff models, Journal of Hydrology, 36:375-381, 1978
- Harbaugh, A.W., and M.G. McDonald. User's documentation for MODFLOW-96, an update to the U.S. Geological Survey Modular Finite-Difference Ground-Water Flow Model. U.S. Geological Survey Open-File Report 96-485. U.S. Geological Survey, Denver, 1996
- Hill, M.C. Methods and Guidelines for Effective Model Calibration. U.S. Geological Survey Water-Resources Investigations Report 98-4005. U.S. Geological Survey, Denver, 1998
- Ho, S.V., C. Athmer, P.W. Sheridan, B.M. Hughes, R. Orth, D. McKensie, P.H. Brodsky, A.M. Shapiro, T. M. Sivavec, J. Salvo, D. Schultz, R. Landis, R. Griffith, and S. Shoemaker. The Lasagna Technology for In Situ Soil Remediation. 2. Large Field Test, Environmental Science and Technology, 33(7): 1092-1099, 1999
- Holliger, G.D., G. Schraa, A.J.M. Stams, and A.J.B. Zehnder. A highly purified enrichment culture couples the reductive dechlorination of tetrachloroethene to growth, Applied Environmental Microbiology, 59: 2991-2997, 1993

- Imam, B., S. Sorooshian, T. Mayr, M. Schaap, H. Wosten, and B. Scholes. IGBP-DIS Working Paper #22: Comparison of Pedotransfer Function to Compute Water Holding Capacity Using the van Genuchten Model in Inorganic Soils. May 1999, Report to IGBP-DIS Soil Data Tasks. National Geophysical Data Center, Colorado 1999  
[http://www.ngdc.noaa.gov/paleo/igbp-dis/frame/publications/wp\\_22/sc\\_wp\\_22.html](http://www.ngdc.noaa.gov/paleo/igbp-dis/frame/publications/wp_22/sc_wp_22.html)
- International Atomic Energy Agency (IAEA). Radioactive waste management glossary. Report IAEA-TECDOC-264, Vienna, Austria, 1982
- Konikow, L.F., and J.D. Bredeheft. Ground-water models cannot be validated, Advances in Water Resources, 15: 75-83, 1992
- Konikow, L.F. Discussion of "The Modeling Process and Model Validation," by Chin-Fu Tsang, November-December 1991 issue, v. 29, no. 6, pp. 825-831, Ground Water, 30(4): 622-624, 1992
- Lee, R.R., and R.H. Ketelle. Contaminant Transport Model Validation: The Oak Ridge Reservation. Oak Ridge National Laboratory, TN, 1988
- Legates, D.R. and G.J. McCabe. Evaluating the use of "goodness-of-fit" measures in hydrologic and hydroclimatic model validation, Water Resources Research, 35(1): 233-241, 1999
- Leijnse, A. and S.M. Hassanizadeh. Model definition and model validation, Advances in Water Resources, 17:197-200, 1994
- Levy, J. A Field and Modeling Study of Atrazine Transport and Fate in Groundwater. PhD dissertation. University of Wisconsin-Madison, 1993
- Mackay, D.M., and J.A. Cherry. Groundwater Contamination: Pump-and-Treat Remediation, Environmental Science and Technology, 23(8): 630-636, 1989
- Mason, A.R., T.J. Franz, M.R. Harkness, and M. Figura. Modeling Natural Attenuation of Chlorinated Solvent Plumes. In: Natural Attenuation Considerations and Case Studies: Remediation of Chlorinated and Recalcitrant Compounds. G.B. Wickramanayake, A.R. Gavaskar, and M.E. Kelley, eds. Battelle Press, Columbus, pp. 113-120, 2000
- Masters, G.M. Introduction to Environmental Engineering and Science. 2<sup>nd</sup> ed. Prentice-Hall, New Jersey, 1997

- Maymo-Gatell, X., Y-T Chien, J.M. Gossett, and S.H. Zinder. Isolation of a bacterium that reductively dechlorinates tetrachloroethene to ethene, Science, 276: 1568-1571, 1997
- Maymo-Gatell, X., T. Anguish, and S.H. Zinder. Reductive Dechlorination of Chlorinated Ethenes and 1,2-Dichloroethane by "*Dehalococcoides ethenogenes*" 195, Applied and Environmental Microbiology, 64(7): 3108-3113, 1999
- McCarty, P.L. Biotic and abiotic transformations of chlorinated solvents in groundwater. In: Symposium on Natural Attenuation of Chlorinated Organics in Ground Water, EPA/540/R-96/509. USEPA, Washington, D.C, pp 5-9,1996
- McCarty, P.L., and L. Semprini. Groundwater treatment for chlorinated solvents. In: Handbook of Remediation. R.D. Norris and others, eds. Lewis Publishers, Boca Raton, pp 17-24, 1994
- McCombie, C., and I. McKinley. Validation—Another Perspective, Ground Water, 31(4): 530-531, 1998
- Micovic, Z. and M.C. Quick. A rainfall and snowmelt runoff modeling approach to flow estimation at ungauged sites in British Columbia, Journal of Hydrology, 226: 101-120, 1999
- Moutoux, D. and J. Hicks. Natural Attenuation of the Building 301 Trichloroethene Plume at Offutt Air Force Base, Nebraska. In: Natural Attenuation of Fuels and Chlorinated Solvents in the Subsurface. Wiedemeier, T.H., H.S. Rifai, C.J. Newell, and J.T. Wilson, eds. Wiley & Sons, New York, pp. 535-551, 1999
- Murphy, E.M., and T.R. Ginn. Modeling microbial processes in porous media, Hydrogeology Journal, 8: 142-158, 2000
- National Research Council. Ground Water Models: Scientific and Regulatory Applications. National Academy Press, Washington, D.C., 1990
- National Research Council. Groundwater & Soil Cleanup: Improving Management of Persistent Contaminants. National Academy Press, Washington, D.C., 1999
- National Research Council. Natural Attenuation for Groundwater Remediation. National Academy Press, Washington, D.C., 2000

- Niederer, U. In Search of Truth: The Regulatory Necessity of Validation. In: Safety Assessment of Radioactive Waste Repositories: Validation of Geosphere Flow and Transport Models GEOVAL-1990. Swedish Nuclear Power Inspectorate (SKI) and the OECD Nuclear Energy Agency, Stockholm, 1990
- Osei, D.N. Field-Scale Testing and Validation of a Numerical Model Code for Modelling Groundwater Flow and Contaminant Transport in a Porous Media. MS Thesis, University of Regina, Regina, Saskatchewan, 1995
- Parsons Engineering Science, Inc. Treatability Study in Support of Monitored Natural Attenuation at Landfill 3 (Site LF-03), F.E. Warren Air Force Base, Cheyenne, Wyoming. STINET Accession Number ADA381632. Denver, 1999  
<http://www.stinet.dtic.mil>
- Popper, K. The Logic of Scientific Discovery. Harper and Row, New York, 1959
- Resele, G., and D. Job. Calibration, Validation and Uncertainty Analysis of a Numerical Groundwater Model. In: Memoires of the 22<sup>nd</sup> Congress of IAH, Vol. XXII, Lausanne, 1990
- Sargent, R.G. Verification and validation of simulation models. In: Progress in Modeling and Simulation, F.E. Cellier, ed. Academic Press, London, 159-169, 1982
- Schlesinger, S., R.E. Crosbie, R.E. Gagne, G.S. Innis, C.S. Lalwani, J. Loch, R.J. Sylvester, R.D. Wright, N. Kheir, and D. Bartos. Terminology for model credibility, Simulation, 32: 103-104, 1979
- Semprini, L., and P.L. McCarty. Comparison between model simulations and field results for in-situ bioremediation of chlorinated aliphatics: part 1. Co-metabolic transformations, Ground Water, 29(4): 475-487, 1991
- Semprini, L., and P.L. McCarty. Comparison between model simulations and field results for in-situ bioremediation of chlorinated aliphatics: part 2. Co-metabolic transformations, Ground Water, 30(1): 37-44, 1992
- Smatlak, C.R., J.M. Gossett, and S.H. Zinder. Comparative kinetic of hydrogen utilization for reductive dechlorination of tetrachloroethene and methanogenesis in an enrichment culture, Environmental Science and Technology, 30: 2850-2858, 1996

- Sorooshian, S., V.K. Gupta, J.L. Fulton. Evaluation of maximum likelihood parameter estimation techniques for conceptual rainfall runoff models: influence of calibration data variability and length of model credibility, Water Resources Research, 19(1): 251-259, 1983
- Sturchio, N.C., J.L. Clausen, L.J. Heraty, L. Huang, B.D. Holt, and T.A. Abrajano, Jr. Chlorine Isotope Investigation of Natural Attenuation of Trichloroethene in an Aerobic Aquifer, Environmental Science and Technology, 32(20): 3037-3042, 1998
- Suarez, M.P. and H.S. Rifai. Biodegradation Rates for Fuel Hydrocarbons and Chlorinated Solvents in Groundwater, Bioremediation Journal, 3(4): 337-362, 1999
- Swanson, M. Natural Attenuation of Chlorinated Solvents: FT-17, Cape Canaveral, Florida. In: Natural Attenuation of Fuels and Chlorinated Solvents in the Subsurface. Wiedemeier, T.H., H.S. Rifai, C.J. Newell, and J.T. Wilson, eds. Wiley & Sons, New York, pp. 516-528, 1999
- Tsang, C-F. The Modeling Process and Model Validation, Ground Water, 29(6): 825-831, 1991
- United States Environmental Protection Agency (USEPA). Use of Monitored Natural Attenuation at Superfund, RCRA Corrective Action, and Underground Storage Tank Sites. Office of Solid Waste and Emergency Response Directive 9200.4-17P, 1999
- United States Environmental Protection Agency (USEPA). National Priorities List (NPL) in the United States, Washington, D.C., 2000  
<http://www.epa.gov/superfund/sites/npl/npl.htm>
- Weaver, J., C.G. Enfield, S. Yates, D. Kreamer, and D. White. Predicting Subsurface Contaminant Transport and Transformation: Considerations for Model Selection and Field Validation, EPA/600/2-89/045. USEPA, Ada, OK, 1989
- Weglarczyk, S. The interdependence and applicability of some statistical quality measures for hydrological models, Journal of Hydrology, 206: 98-103, 1998
- Wiedemeier, T.H., M.A. Swanson, D.E. Moutoux, J.T. Wilson, D.H. Kampbell, J.E. Hansen, P. Haas. Overview of the Technical Protocol for Natural Attenuation of Chlorinated Aliphatic Hydrocarbons in Ground Water Under Development for the U.S. Air Force Center for Environmental Excellence. In: Symposium on Natural Attenuation of Chlorinated Organics in Ground Water, EPA/540/R-96/509. USEPA, Washington, D.C, pp 35-59, 1996

- Wiedemeier, T.H., H.S. Rifai, C.J. Newell, and J.T. Wilson. Natural Attenuation of Fuels and Chlorinated Solvents in the Subsurface. Wiley & Sons, New York, 1999
- Wilks, D.S. Statistical Methods in the Atmospheric Sciences: An Introduction. Academic Press, San Diego, 1995
- Willmott, C.J. On the Validation of Models, Physical Geography, 2: 184-194, 1981
- Willmott, C.J. Some comments on the evaluation of model performance, Bulletin of the American Meteorological Society, 63: 599-609, 1982
- Willmott, C.J. On the Evaluation of Model Performance. In: Physical Geography in Spatial Statistics and Models, G.L. Gaile and C.J. Willmott, eds. D Riedel Publishing, Dordercht, pp. 443-460, 1984
- Willmott, C.J., S.G. Ackleson, R.E. Davis, J.J. Feddema, K.M. Klink, D.R. Legates, J. O'Donnell, and C.M. Rowe. Statistics for the evaluation and comparison of models, Journal of Geophysical Research, 90:8995-9005, 1985
- Wilson, J.T. and B.H. Wilson. Biotransformation of trichloroethylene in soil, Applied Environmental Microbiology, 49: 242-243, 1985
- Zar, J.H. Biostatistical Analysis. 4<sup>th</sup> ed. Prentice Hall, Upper Saddle River, NJ, 1999

## Vita

Harold C. Young enlisted in the United States Navy in 1988 to work in the Naval Nuclear Propulsion Program. He was selected to attend the United States Naval Academy in 1991, from which he graduated with a degree in physics.

Commissioned as a second lieutenant in the United States Marine Corps, Lieutenant Young was assigned to 1<sup>st</sup> Force Service Support Group (1<sup>st</sup> FSSG) as a combat engineer, where he worked for 7<sup>th</sup> Engineer Support Battalion and MEU Service Support Group-15. After a promotion, Captain Young attended the Air Force Institute of Technology, where he obtained his Master's Degree in Engineering and Environmental Management. Captain Young is currently assigned to Camp Pendleton, CA as the Environmental Compliance Manager for 1<sup>st</sup> FSSG.

# REPORT DOCUMENTATION PAGE

*Form Approved*  
OMB No. 074-0188

The public reporting burden for this collection of information is estimated to average 1 hour per response, including the time for reviewing instructions, searching existing data sources, gathering and maintaining the data needed, and completing and reviewing the collection of information. Send comments regarding this burden estimate or any other aspect of the collection of information, including suggestions for reducing this burden to Department of Defense, Washington Headquarters Services, Directorate for Information Operations and Reports (0704-0188), 1215 Jefferson Davis Highway, Suite 1204, Arlington, VA 22202-4302. Respondents should be aware that notwithstanding any other provision of law, no person shall be subject to a penalty for failing to comply with a collection of information if it does not display a currently valid OMB control number.

**PLEASE DO NOT RETURN YOUR FORM TO THE ABOVE ADDRESS.**

<b>1. REPORT DATE (DD-MM-YYYY)</b> 20-03-2001		<b>2. REPORT TYPE</b> Master's Thesis		<b>3. DATES COVERED (From - To)</b> Aug 1999 - Mar 2001	
<b>4. TITLE AND SUBTITLE</b>  QUANTITATIVE VALIDATION OF A MODEL OF CHLORINATED ETHENE NATURAL ATTENUATION				<b>5a. CONTRACT NUMBER</b>	
				<b>5b. GRANT NUMBER</b>	
				<b>5c. PROGRAM ELEMENT NUMBER</b>	
<b>6. AUTHOR(S)</b>  Young, Harold C., Captain, USMC				<b>5d. PROJECT NUMBER</b> If funded, enter ENR #	
				<b>5e. TASK NUMBER</b>	
				<b>5f. WORK UNIT NUMBER</b>	
<b>7. PERFORMING ORGANIZATION NAMES(S) AND ADDRESS(S)</b>  Air Force Institute of Technology Graduate School of Engineering and Management (AFIT/EN) 2950 P Street, Building 640 WPAFB OH 45433-7765				<b>8. PERFORMING ORGANIZATION REPORT NUMBER</b>  AFIT/GEE/ENV/01M-25	
<b>9. SPONSORING/MONITORING AGENCY NAME(S) AND ADDRESS(ES)</b>  Air Force Center for Environmental Excellence/Technology Transfer Division Attn: Maj Jeff S. Cornell 3207 North Road, Building 532 Brooks AFB TX 78235-5357 (210) 536-4329				<b>10. SPONSOR/MONITOR'S ACRONYM(S)</b> AFCEE/ERT	
				<b>11. SPONSOR/MONITOR'S REPORT NUMBER(S)</b>	
<b>12. DISTRIBUTION/AVAILABILITY STATEMENT</b>  APPROVED FOR PUBLIC RELEASE; DISTRIBUTION UNLIMITED.					
<b>13. SUPPLEMENTARY NOTES</b>					
<b>14. ABSTRACT</b> Chlorinated ethenes are among the most prevalent groundwater contaminants at hazardous waste sites nationwide. In an attempt to manage the risks posed by these contaminants, while controlling costs, monitored natural attenuation (MNA) is being considered as a remediation strategy at many sites. MNA relies on naturally occurring physical, chemical, and biological processes in the subsurface to reduce the risk posed by the contamination. The implementation of MNA, however, requires a detailed understanding of these processes, and how they impact contamination at a particular site. One way to gain this understanding is through contaminant fate and transport modeling. In this study, a deterministic model that includes relevant fate and transport processes was applied to a chlorinated ethene-contaminated field site, at which spatial and temporal data had been collected. Parameters used for model input were obtained from the literature, experimental data, and by calibrating the model using concentration data from 1993. The model was then run in a predictive mode, and simulation results were compared to field data from 1999. Model performance was measured by comparison of observed and simulated concentration contour plots and evaluation of goodness-of-fit statistics. Over the six years the model was run in a predictive mode, the model was found to predict contaminant concentrations reasonably well for the three contaminants that were monitored.					
<b>15. SUBJECT TERMS</b> Contaminant Fate and Transport, Monitored Natural Attenuation, Quantitative Validation, Field Validation, Groundwater Modeling, Chlorinated Ethenes, Trichloroethylene, Dichloroethylene, Vinyl Chloride, Reductive Dehalogenation, Aquifer Remediation, Goodness-of-Fit Statistics, Linear Equilibrium Sorption					
<b>16. SECURITY CLASSIFICATION OF:</b>		<b>17. LIMITATION OF ABSTRACT</b>	<b>18. NUMBER OF PAGES</b>	<b>19a. NAME OF RESPONSIBLE PERSON</b>	
a. REPOR T	b. ABSTR ACT			Professor Mark N. Goltz, ENV	
U	U	UU	95	<b>19b. TELEPHONE NUMBER (Include area code)</b> (937) 255-3636, ext 4638	
c. THIS PAGE					
U					

**Standard Form 298 (Rev. 8-98)**  
Prescribed by ANSI Std. Z39-18

*Form Approved*  
OMB No. 074-0188